



better urban lifestyle





EDITORIAL

01

BETTER URBAN LIFESTYLE

The age of urban Micromobility has begun! Cities are growing exponentially and more and more people are moving to urban centers. In this rapidly changing world, our vision of space-saving and practical Micromobility is more relevant than ever. Society and its mobility requirements are evolving and environmentally friendly vehicles such as our E-scooters or the Microlino will play an important role in individual transportation. We continue to focus on pioneering innovations and work together with a passionate team in over 80 countries to create a **"better urban lifestyle"** for people of all ages.

Thank you for your support.

Wim, Janine, Merlin und Oliver Ouboter

Wim Ouboter Janine Ouboter Merlin Ouboter Oliver Ouboter

CONTENT



01 EDITORIAL

Better urban lifestyle.

2



02 MICRO SUCCESS STORY

«Have you ever had the feeling that a distance is too far to walk but too close to get the bike or even the car out of the garage?»

9-12



03 MICROLINO STORY

How much car do you need for daily use?

13-18

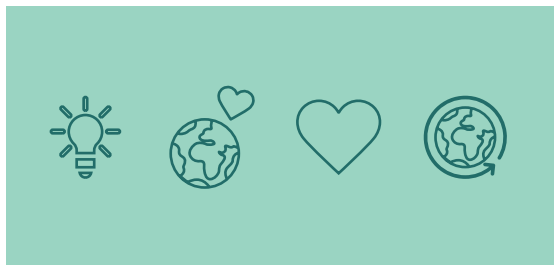

04 ABOUT MICRO

Our vision & values.

19-20



05 SUSTAINABILITY & SOCIAL RESPONSIBILITY

We are fighting throwaway society!

21-24

MICRO ECO SCOOTER & 1% FOR THE PLANET

In collaboration with 1% for the Planet, we donate 1% of the sales of our ECO product line to charitable organizations dedicated to protect the environment.

25-26

06



INNOVATION/ MICRO DESIGN LAB

Some innovate, others imitate.

27-30

07



E-SCOOTERS - THE NEW MOBILITY

The key to success? Being different!

31-32

08



ONE FAMILY, ONE BRAND

«For us, the boundaries between work and private life are fluid.»

33-34

09



MICRO COOPERATIONS

Fendi, Mercedes, Peugeot, Mazda & Suitsupply.

35-38

10



CONTENT



11 CORPORATE SCOOTERS
Environmentally friendly and space-saving mobility solutions for companies.

39-40



12 MICRO DISPLAYS AROUND THE WORLD
Micro products are available in over 80 countries - whether in specialist shops, online or in our flagship stores.

41-42

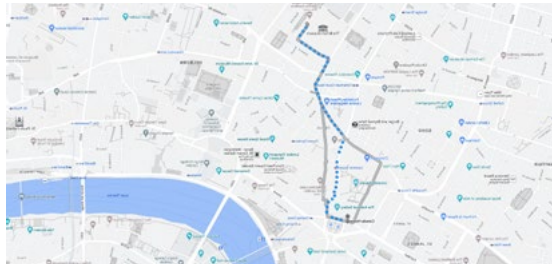

13 TIME SAVING CALCULATOR
Calculate how much time you will save if you cover the "last mile" by Micro Scooter instead of walking.

43-44



14 MICRO SCOOTER SAFETY TRAINING
Correct braking must be learned.

45-46



15 PRODUCT INNOVATIONS
We are reinventing mobility.

47-48

MICRO COMMUNITY & CELEBRITIES
Become part of the Micro Family!

49-50

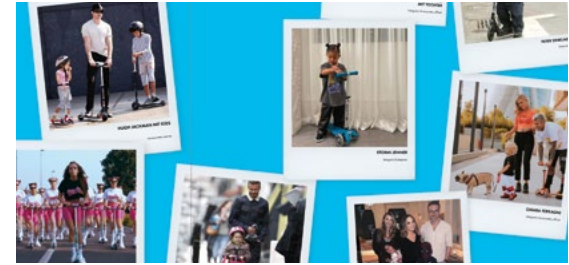

16

CHILLI
Absolute passion for stunt scooting and 100% support for the sport.

51-52



17

MICRO SKATES
Discover the inline skates product line from Micro.

53-54

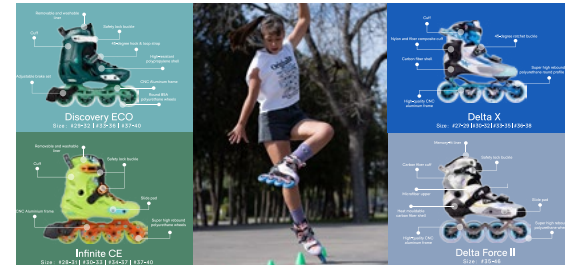

18

MICRO & INDIANA
Joining forces for the distribution of skateboards and balance boards.

55-56



19

WIM OUBOTER
In 1997, the visionary Wim Ouboter reinvented the scooter: But how does the scooter pioneer live and breathe?

57-58



20

PRODUCTS



KIDS
61



TRAVEL
215

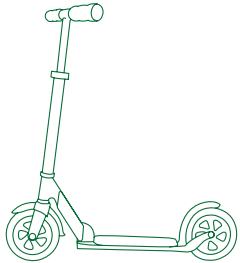
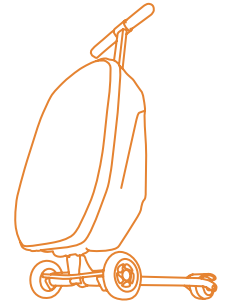

ADULTS
143

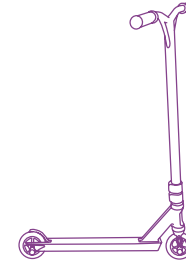

FREESTYLE
235



ELECTRIC
181

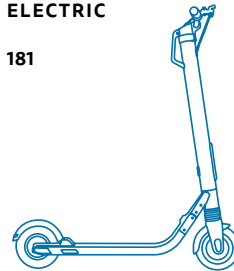

ACCESSORIES
247

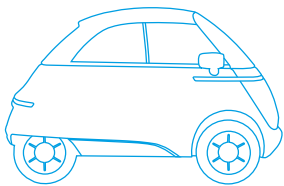

MICROLINO
201

INDEX
260





From kick scooter to
Microlino - Discover the
Micro Story as a video!

MICRO SUCCESS STORY

«Have you ever had the thought that a distance is too short to get the car out of the garage, but at the same time too far to walk?»

This dilemma also plagued Wim Ouboter as he made his way from his apartment in Zurich to his favorite sausage stand, the legendary Sternengrill. In search of a practical solution for this short, one-kilometer Micro-distance, the Swiss entrepreneur quickly invented the original kickboard. However, the attempt to turn his vision of Micromobility into reality posed a challenging question: **How can you successfully launch such a product on the market with limited financial resources and no experience in this sector?**



Wim Ouboter with a Micro Scooter prototype



1997

Wim wanted to team up with car manufacturer Smart and equip every car trunk with a Micro Scooter. The project failed because delivery of the city cars was delayed due to technical and financial problems.



2001

Wim's strategy is: innovation. He developed the Mini Micro, a colored version of the kickboard for children. Further innovations followed and today Micro offers over 50 mobility products for children, teenagers and adults, which are successfully sold in over 80 countries.



2013

In 2013, Micro proudly presented the first E-scooter on the market, the eMicro one. This compact and lightweight electric scooter with motion control received numerous prestigious awards. The valuable experience gained in the field of electromobility since the market launch of the first eMicro one, have contributed significantly to the development of our new product line.



1998

After some initial stumbling blocks, Wim found a suitable sales partner in the sports brand K2. Together, they launched the three-wheeled kickboard on the market and celebrated huge sales successes.

His pronounced innovative spirit had already led Wim to a new idea: the three-wheeled kickboard. It was supposed to be easier to ride than a skateboard, but still convey the same cruiser feeling.



Wim used the income from kickboard sales to found his own company, Micro Mobility Systems AG. Now his two-wheeled Micro Scooter also made its big breakthrough. Every day, 80,000 Micro Scooters were sold, and after a year, over 30 million.



2015

In 2015, Wim's sons, Oliver and Merlin, started developing the electric city car Microlino. Over 36,000 reservations have been received worldwide. Series production started at the end of 2022. Today, the Microlino is taking Europe by storm.

2020

Micro was voted the fifth most innovative company in Europe by Fast Company magazine. Winners in previous years include companies such as Apple, Novartis and Spotify.



2021

Micro is developing a sustainable children's scooter product line that is manufactured using recycled ocean plastic. Micro donates 1% of the sales of this ECO line to non-profit organizations dedicated to environmental protection.



2022

For over two decades, Micro has shaped the development of urban mobility with exclusive innovations. To mark the 25th anniversary of the Micro Scooter, the Swiss company is reviving a touch of nostalgia with the anniversary model "Micro Navigator" in a unique retro look.



OVER 30 MILLION SALES

Just one year later, the business collapsed completely. The market was flooded with pirated copies. More than 500 factories copied Wim's Micro Scooter. A ruthless price war began.

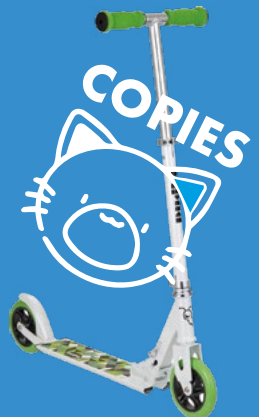



MICROLINO STORY

«How much car do you really need in everyday life?»

This was the question asked by Wim, Oliver and Merlin Ouboter.

Conventional cars are often too big and too heavy for the daily distances. Statistically speaking, on average only 1.2 people travel in a car for daily distances of 35 kilometers. So how should the ideal vehicle be designed for these short everyday journeys?



2015

The Ouboters realized that the perfect vehicle for everyday commuting was a mix of motorcycle and car. Such concepts already existed in the 1950s. Inspired by the old cabin cars, they created the first designs for the Microlino.

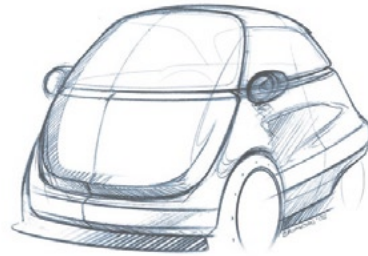

The design and technical specifications were finalized together with the Swiss University of Applied Sciences ZHAW and DW. The next step - the construction of a prototype - was realized in China in the second half of 2015.

After a few months, the time had come and the prototype arrived in Switzerland. But then something unexpected happened: the Microlino prototype fell off the forklift truck and was badly damaged.



2016

But the three founders did not give up. The vehicle was repaired in time for the Geneva Motor Show in March 2016. The efforts were more than worth it - over 500 reservations were made in just two days.

In April 2016, the Microlino team started a collaboration with Tazzari, an Italian specialist for electric vehicles. Due to the sale of the Microlino manufacturer to the German company Artega, series development has come to a standstill.



2020

In 2020, Merlin and Oliver received a spot on the "Forbes 30 under 30 Europe" list. Every year, the business magazine selects young, creative leaders and innovative entrepreneurs who have a decisive influence on the economy and society.



2021



We are delighted that the Microlino has won the Good Design Award in the "Transportation" category. The Global Design News magazine, which is part of the Chicago Athenaeum organization, has also named the Microlino Car of the Year 2021.

2022

Series production of the Microlino 2.0 started in 2022 in the newly founded Microlino Italia business unit. New production partner is the Italian company Cecom.



Two more world firsts were presented at the Paris Motor Show: the Microlino Spiaggina Concept and the Microlino Lite. The Microlino Lite is a version limited to 45 km/h that can also be driven without a driver's license. The Microlino Spiaggina has a beach buggy look without side and rear windows, but with a white-blue fabric top.



- LITE -



Spiaggina

2023

On June 24, 2023, the world's first official Microlino meeting took place. The highlight of the event was undoubtedly the impressive Microlino convoy that moved through the busy streets of Zurich. Over 70 Microlinos in an impressive parade grabbed the attention of the crowd. But that was not all, an unforgettable ferry ride across Lake Zurich with 54 Microlinos on board rounded off this historic meeting.



Check out the aftermovie

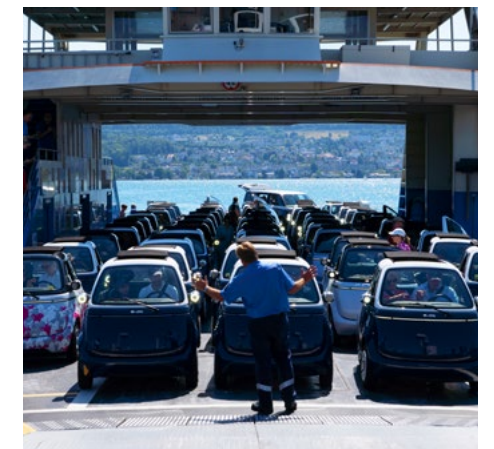

MICROLINO MEDIA REPORTS



The Microlino has already been recognized by prestigious newspapers and blogs around the world as well as on various social media platforms in impressive articles and posts.

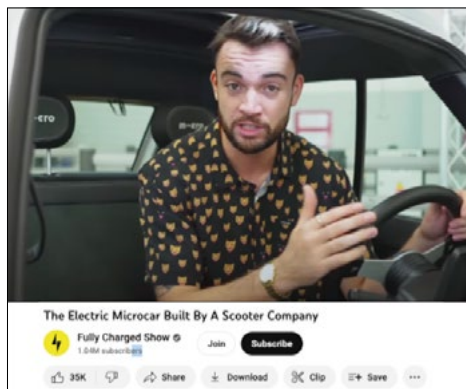
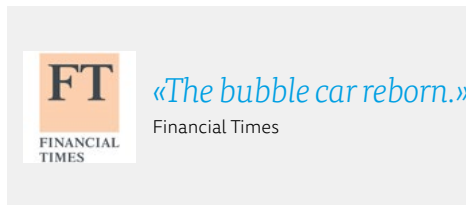
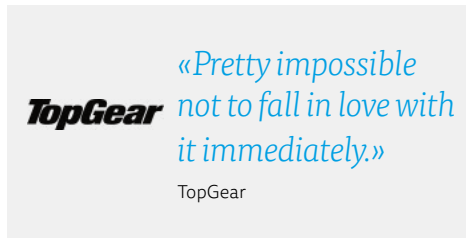

MICROLINO PRODUCTION

BORN IN SWITZERLAND - RAISED IN ITALY.

Our factory in Turin, Italy, in the historic cradle of the Italian automotive industry, is the ideal location for the production of the Microlino. On our **3,000 square meter solar-powered final assembly line**, we use state-of-the-art equipment and systems to ensure that every Microlino meets the highest quality standards.

red in the same factory that produces parts for renowned car manufacturers such as McLaren, Aston Martin and Renault.

The Microlino is the most sustainable individual mobility product on the market, with 50% fewer parts than a normal car. It is the perfect combination of efficiency and comfort, offering weather protection, freedom of movement and cargo space in a small but mighty package.

Our production process is divided into three main areas: Body work, Painting and Assembly Line. The self-supporting steel and aluminum body of the Microlino, a masterpiece of our production partner CECOMP, is manufactu-



Microlino production and assembly line in Turin (IT)



ABOUT MICRO

90 MILLION SALES

Over 90 million scooters have already been sold worldwide.

80 COUNTRIES

Micro sells its products in more than 80 countries.

80 MILLION TURNOVER

Micro generates an annual turnover of around 80 million dollars.

100% FAMILY OWNED

The company is 100% owned by Wim Ouboter and his family.

MORE THAN 50 PRODUCTS

Micro offers over 50 mobility products for kids, teens and adults.

10'000 SALES POINTS

We sell our products in over 10,000 locations worldwide.

From kick scooter to Microlino
Discover the Micro Story in
our brand video!



Our Vision

At Micro, we're passionate about making mobility more practical, sustainable and fun. We believe that mobility is more than just getting from A to B - it's about enjoying the journey, exploring new places and moving freely however you want. Our goal is to create innovative solutions that allow you to do just that. Whether you're commuting to work, running errands or simply spending quality time with family and friends, Micro lets you dive deep into the world of Micromobility.

But our vision goes even further: **We want to reimagine future mobility.** With our enthusiasm for innovative and high-quality Micromobility products, we are committed to bringing positive change and making sustainable mobility convenient, accessible and fun for everyone. Our pioneering spirit, deeply rooted in our family values, drives us forward and our commitment to sustain-

ability guides us on our journey to change the way we live and create an improved world for generations to come.



Our Values

04

PIONEERING SPIRIT



At Micro, we are passionate pioneers of Micromobility. Our innovations, from our world-renowned foldable aluminum scooter to the Microlino, the world's smallest electric city car, are proof of this. With more than 50 ground-breaking products, we are constantly pushing the boundaries of urban mobility and creating fascination.

FAMILY VALUES



As a Swiss family business, fairness, quality, innovation and sustainability are the cornerstones of our actions. These values permeate all areas of our business, let it be the careful selection of sustainable materials for our products or the transparency of our sales processes. They are also reflected in our commitment as an employer and an active part of society.

PLANET FRIENDLY



We are deeply convinced that sustainable mobility is shaping the future. Our commitment to sustainability is global and is reflected in numerous local initiatives. Our passion for high-quality and sustainable mobility solutions drives us and contributes to creating a better urban lifestyle.

BUILT TO LAST



Our products are not only stylish, but also designed to last. Thanks to interchangeable parts, Micro products can be used by several generations. In addition, we offer worldwide repair and spare parts services to minimize our environmental impact. We invest in quality and durability, helping to create a more sustainable future.



We are fighting throwaway society!

SUSTAINABILITY & SOCIAL RESPONSIBILITY

QUALITY AND SAFETY ARE OUR TOP PRIORITIES

Our products are characterized by exceptionally high quality and durability. We only use carefully selected raw materials. New products undergo a strict quality control system with various test procedures at every stage of development and production. This ensures that all requirements of national and international safety standards are met.



WE ARE REDUCING OUR ECOLOGICAL FOOTPRINT

We are constantly striving to optimize our product range and the entire Micro value chain and make them more sustainable. Among other things, recycling and the reduction of plastics in our products and packaging is a high priority. We are also gradually increasing the use of FSC-certified paper for our packaging.

Repairing instead of throwing away

Contrary to today's throwaway society, Micro products are made for a long life. We offer a unique worldwide repair and spare parts service for every product. Our own global sales and service network guarantees the professional maintenance of our products, which has a positive impact on their lifespan and protects resources.

OUR PRODUCTS HAVE AN ABOVE-AVERAGE LIFESPAN

The handlebars of our kids products are height-adjustable and grow with the user – from the first steps to pre-school age. A Micro Mini2Grow, for example, is used for an average of six years. Compared to a McDonald's toy, which is only used for a few hours at most, or a Barbie doll, which the child plays with for a year at best, this figure is considerable. Additionally, with our products, kids go outside in the fresh air, which promotes physical health and development.



UNBELIEVABLE BUT TRUE: THIS MICRO SCOOTER IS 22 YEARS OLD!

A customer in the Czech Republic inherited the scooter from his father and is planning to replace the wheels and handles so that his son can ride it. He is delighted with the longevity and quality of the scooter and has no plans to buy a new one.



EVEN A DUTCH BRIDGE CANNOT AFFECT THE QUALITY OF OUR SCOOTERS!

During a family vacation in the Netherlands, fascinated tourists marveled at the lifting bridge in Maastricht. They did not notice how the bridge closed and trapped their child's Micro Scooter. After about half an hour, the bridge lifted again and the scooter was freed without damage.

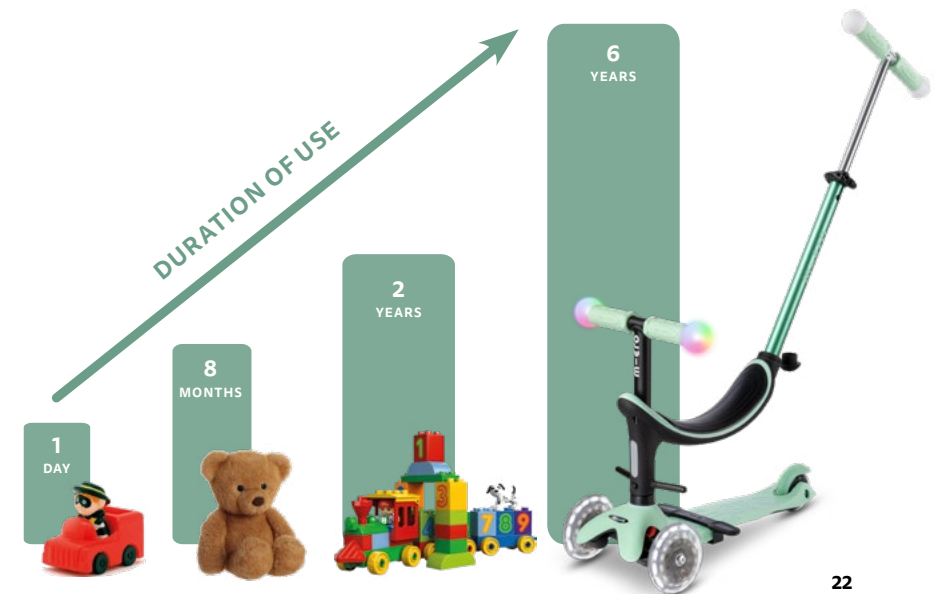

We want to bring about a change in society!

OUR STRATEGY: PRIVATE E-SCOOTERS INSTEAD OF RENTAL SCOOTERS

The behavior of road users has changed: people are using more and, in particular, different means of transport on their journeys. As the inventors of micromobility, we have been convinced for over 25 years that a scooter is the ideal means of transportation for cities - light, compact, safe and sustainable! Contrary to developments in the field of free-float E-scooter sharing, we are pursuing the strategy of personal electric scooters. In our opinion, the business model originating in the USA is neither sustainable nor safe. A study pu-

blished by ETH in January 2022 shows that privately owned E-scooters, in contrast to sharing offers, actually improve the ecological balance.* Owning your own E-scooter means taking responsibility for its condition and handling. Thanks to their low weight and easy foldability, our E-scooters can easily be taken into the home or office and combined with public transport. It is also dangerous to use E-scooters in busy city centers without any training.

I  MY OWN E-SCOOTER

WE REINVEST 80% OF OUR PROFITS IN THE DEVELOPMENT OF SUSTAINABLE MOBILITY SOLUTIONS

With the Micro Scooter, Swiss visionary and pioneer Wim Ouboter revolutionized the way we get around in urban areas 25 years ago and laid the foundation for the current micromobility trend. With the Microlino, he now wants to take his vision of sustainable and space-saving urban mobility to a new level. His sons Merlin & Oliver are joining him in this endeavor.



2491.2 kg CO₂
saved over 1 year



4.34 Years
heating of a 1.5 room apartment

DRIVE ECO



19.93 Flights
from London to Paris



0.01 Flights
to the Moon

Annual CO₂ savings compared to a gasoline powered car*

EFFICIENCY BEAST MICROLINO

The Microlino not only impresses with its cuddly appearance, but is also extremely environmentally friendly! Compared with an annual journey of 15,000 kilometers in a petrol car, the Microlino can save 2,491 kg of CO₂. This is equivalent to 20 flights from

London to Paris or 0.01 flights to the moon and back. Due to its light weight, the Microlino consumes around 60% less energy than a conventional electric car.

Calculate your annual CO₂ savings with the Microlino.



EXPLORING TODAY PROTECTING TOMORROW

MICRO ECO PRODUCT LINE

Around 10 percent of plastic waste in the oceans comes from fishing. Every year, an estimated 640,000 tons of nets and other equipment are left behind in the oceans. Our sustainable Micro Kids Scooters are made with part of this waste, which is collected in landfills and then recycled. The ECO product line is another step towards sustainability for Micro. Not only have we been selling products for more than 25 years that can be passed down through generations thanks to their durability, but we have also set ourselves ambitious sustainability targets that we are gradually expanding.

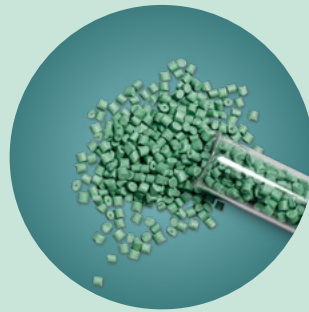

06



PARLEY

Micro donates 1% of its ECO product line sales to charitable organizations.



MICRO IS A PROUD MEMBER OF 1% FOR THE PLANET

In partnership with 1% for the Planet, we donate one percent of the sales of our ECO product line to non-profit organizations dedicated to protecting the environment. Proceeds from **Micro support Parley's educational programs to provide global access to ocean**

education, tools and experiences, promote ocean conservation and support a network of leaders called Ocean Guardians. Learn more about Parley and their mission at www.parley.tv.

«We recognize that the challenges facing our world are too great for one person or one organization to solve alone. Companies like us have an even greater obligation to help. Our partnership with 1% for the Planet is another step in the right direction.»

Wim Ouboter, Micro Founder & CEO

eco

8 Million
tons of plastic waste end up
in our oceans every year.

Plastic Pollution
is the most widespread problem
affecting the marine environment.

11%
of it stems from the
maritime industry.

We recycle
fishing nets, ropes and trawls into
Micro Scooters.

Benefits
reducing landfilling
reducing marine pollution
reducing loss of valuable
resources.



INNOVATION

SOME INNOVATE, OTHERS IMITATE.

For over 25 years, Micro has been shaping the development of urban mobility with exclusive innovations. Starting with the world famous Micro Scooter, to the revolutionary Scooter Luggage, a suitcase with a fold-out kickboard, to the latest coup, the Microlino the electric city car.

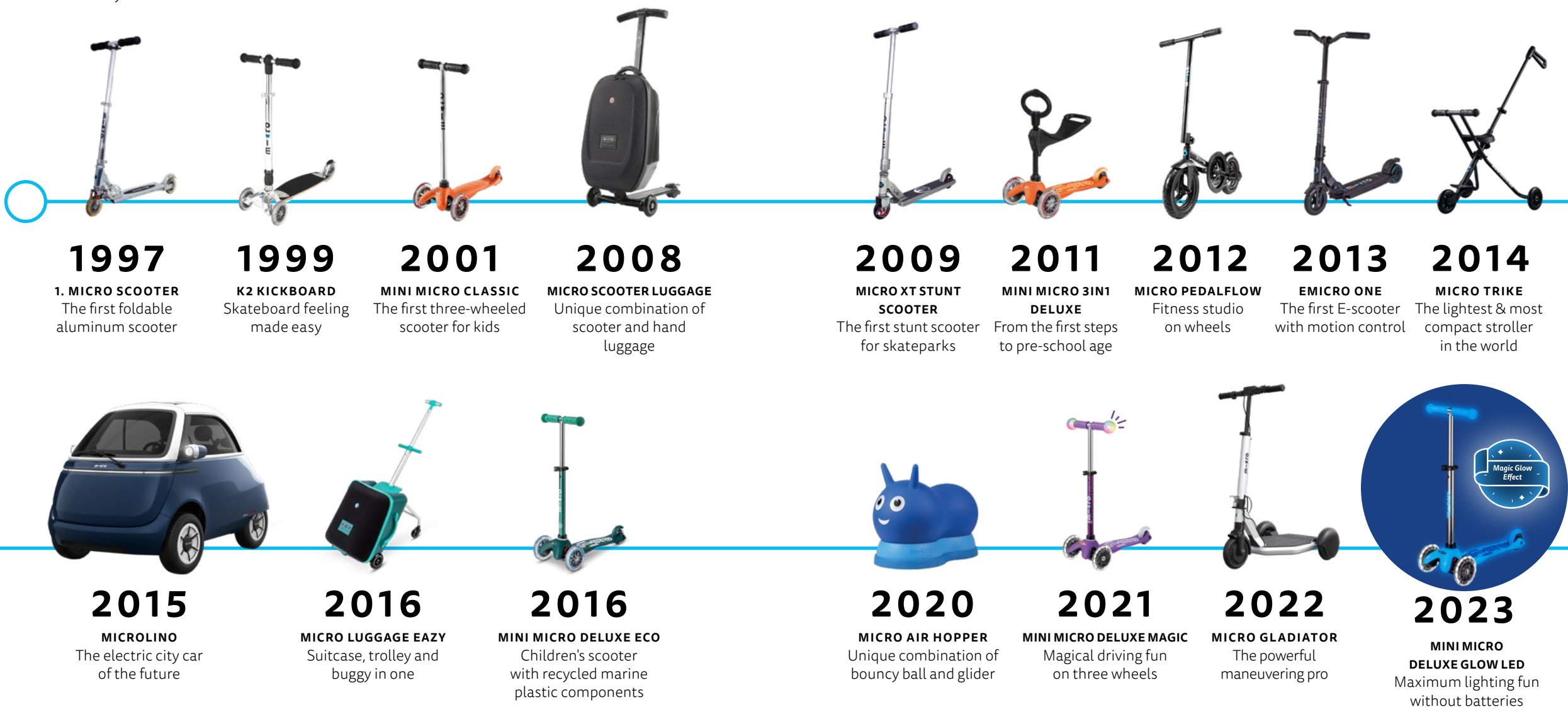

«Innovation is our passion!»

Since Micro Mobility Systems was founded, innovation has been a major part of the company's DNA. True to the vision of a "better urban lifestyle", Micro now offers over 50 different mobility products for kids, teens and adults and is the global market leader in the premium segment. The spectrum ranges from the popular children's scooter to stylish electric scooters and the latest coup, the Microlino. The heart of this tireless innovation process is the Micro Design Lab in Küsnacht ZH - this is where new ideas are tinkered with and the first prototypes are created with passion and dedication.

In this interview, Yannick Lissanda, Head of Micro Design Lab, tells us where he gets his inspiration for new products and what makes Micro's product design unique. Your story - how you came to Micro - is a rather unconventional one. Why don't you tell us ...



Yannick Lissanda, Head of Micro Design Lab

«Micro's product design is characterized by a certain simplicity and durability»

After completing my Bachelor's degree in Industrial Design in Lausanne, I gained my first professional experience at "greutmann bolzern designstudio". I then worked for Adidas for two years and also worked as a freelance product designer on various projects. I have been an enthusiastic Micro fan since I was 12 years old. I used to do my weekly shopping with the Micro Flex. One day I had the idea that it would be much more practical if I could attach my shopping bags to the scooter instead of having to ride home one-handed. So I built a prototype and wrote an e-mail to Micro. Then everything happened very quickly: after two exciting conversations, I started as a Product Designer at Micro. I've now been here for 6 years and head up the Micro Design Lab.

Where do you get the ideas and inspiration for new products?

Curiosity and observation are the be-all and end-all. People and nature are my greatest inspiration.

If I don't get any further, I go to the place where the product will later be used. The ideas then come all by themselves.

And when I'm wearing my favorite grey sweater and have my hood up, my colleagues in the office also know that my head is spinning and I'm "brainstorming" new ideas. It's best not to disturb me then.

What is the biggest challenge when designing a new product?

Expectations.

From whom?

The difficulty lies in doing justice to all the different parties. I hear from the management: "That's too expensive." From the engineers: "It won't last, it won't work like that." From marketing: "That doesn't suit our image." Then there are the sales people, the factory and, of course, the customers, who are ultimately the most important. I want to satisfy all these groups, which is not always easy.

What characterizes Micro's product design?

The Mini Micro, for example, has a timeless design that lives on over the years and always finds its target group without having to change much. This is by no means a matter of course, especially in the scooter sector, as the market is changing very quickly.

What role does sustainability play?

We select the best materials for each project, we test our products according to international standards so that they last as long as possible, we only use as much material as necessary and no more and, finally, we are constantly looking for new, more environmentally friendly materials and production processes. So you could say that sustainability plays a very central role. But it is also important to mention that we

need the support of our customers, who also play their part by making conscious purchasing decisions.



Yannick Lissanda and Roberto Souza, Micro Design Lab



Product sketches of the Mini2Grow & Microlino

THREE CATEGORIES OF MICROMOBILITY

DISTANCE SHARE IN %

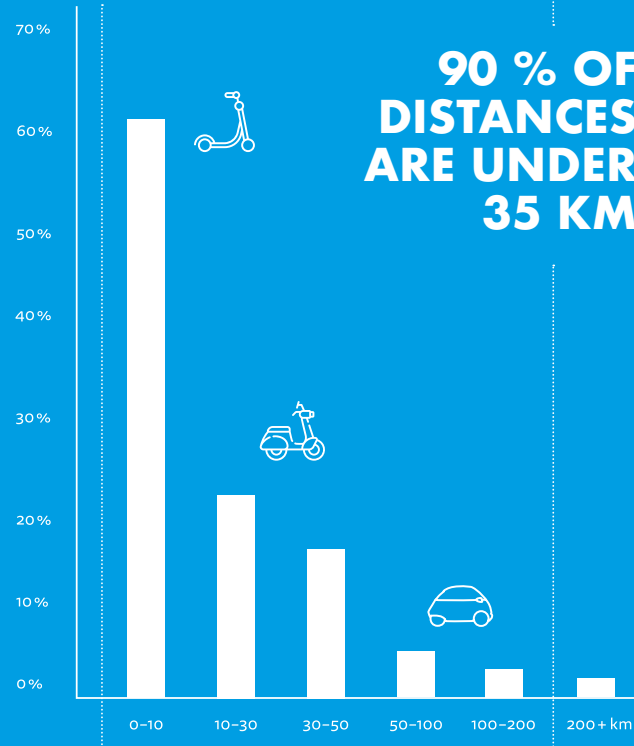

90 % OF DISTANCES ARE UNDER 35 KM

Think about it: When was the last time you drove over 200 km in one day? How often have you had more than two people in your car? Micromobility is the better choice for 95% of journeys, but there is no one-size-fits-all solution.

Some people live close to the city and need small and compact means of transportation, while others live in less well-connected suburbs or in cold regions. Regardless of the conditions, it is important to find environmentally friendly and space-saving mobility options without sacrificing comfort. We have therefore divided Micromobility into three categories. Which one suits you best?



E-SCOOTER & E-BIKE

Ideal for short distances of up to 30 km and in combination with public transport.



MICROLETTA

Ideal for medium distances of up to 100 km and for weaving your way through traffic.



MICROLINO

Ideal for riding medium to long distances of up to 200 km.

WHAT IS THE FUTURE OF E-SCOOTERS?

08



Originally known as sharing products, E-scooters are no longer solely reliant on the success of sharing platforms. Sharing was a major step in the global spread of E-scooters and has increased their acceptance as a means of transportation. Now users are realizing that ownership makes economic and environmental sense. In general E-scooters are increasingly seen as a cost-effective, practical alternative to bicycles and E-bikes. Who knows, maybe one day we will teach our children to use E-scooters as naturally as riding a bike.

RETHINKING THE E-SCOOTER BUSINESS MODEL

It is no longer a question of convincing consumers of the benefits of E-scooters – a short ride is enough to recognize the advantages. Rather, companies, universities, cities and public transportation companies need to be convinced that Micromobility can be a valuable addition to their existing services. In an industry where players are still in the process of differentiating themselves, this could be the key to success: being different, really different.



Micro Gladiator



ONE FAMILY, ONE BRAND

09

Who does what in the company?

Wim: My boys, Oliver and Merlin, manage the Microlino project and the Micro marketing team. My wife Janine is the head of finance and looks after the figures. As the founder, I'm mainly involved in the strategic side of Micro and Microlino, but I also like to get involved in product development.

«For us, the borders between work and private life are fluid.»

What are the advantages and disadvantages of the whole family working in the same company?

Janine: For us, the boundaries between work and private life are fluid. Business topics are often discussed during dinner. Depending on the situation, this can sometimes get louder with our two hotheads Wim and Merlin. I often mediate between the two so that we can end the evening peacefully on the sofa.

Oliver and Merlin, how long have you been involved in the company?

Oliver: Ever since we were children, we were the first guinea pigs for all new Micro products. We learned a lot about the company at a young age and our parents always took our opinions seriously. At school, when the freestyle scene came up, we started selling trick scooters from our workshop. With the

Microlino we want to take Micro one step further – from two to four-wheeled mobility products.

What have you learned from your parents and what have they learned from you?

Merlin: I think we learned a lot about entrepreneurship and management from our parents. They always met us as equals –

despite the age difference. For me, this is the secret ingredient for a successful family business. On the other hand, they learn from us how the younger generation sometimes solves problems in a different way. The Microlino team is a relatively young team, but at the end of the day it needs the same leadership qualities as it did 25 years ago.

«They always took us seriously, independently of our age.»



MICRO COOPERATIONS

FENDI

Elegance on wheels

The two renowned brands, Micro and Fendi, share a passion for quality, exclusive design and innovation. Together, they launched two limited-edition kids' scooters on the market in February 2021.

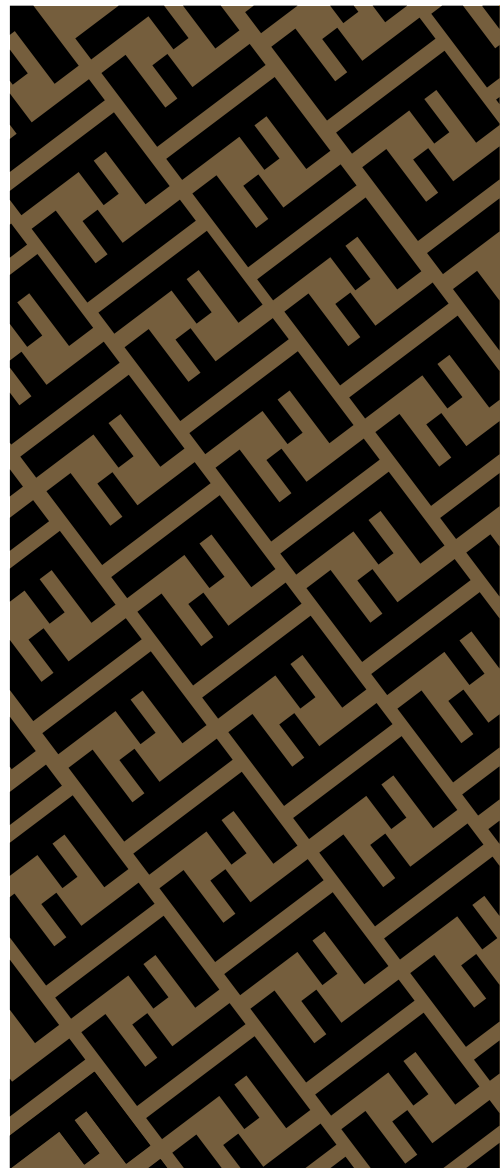

Micro for FENDI Kids Scooter



Micro for FENDI Adult Scooter

Zero emissions on the last mile with the new Mercedes-AMG E-scooter

MERCEDES

By the end of this decade, the brand with the star will be pursuing a clear "electric only" strategy working consistently towards an emission-free future. Innovative mobility solutions will help significantly to improve the quality of life in cities. The Micro X Mercedes-AMG E-scooter is an emission-free solution for mobility on the so-called "last mile"



MICRO X MERCEDES-AMG E-SCOOTER



Dutch menswear label meets Swiss kickboard pioneer

SUITSUPPLY

The search for the unconventional has brought the two successful brands together - the result: a unique piece of luggage on wheels. The Race Case with its Italian calfskin finish and smooth textured surface is guaranteed to leave a lasting impression as you approach the check-in counter.



SUITSUPPLY TRAVEL SCOOTER

Focus on innovation

MAZDA

In collaboration with the Japanese car manufacturer Mazda, the Swiss family business Micro has developed a stylish, compact and handy E-scooter for the last mile. The Micro Commuter weighs just 10 kilograms and is particularly ideal for commuters and short-distance riders who value high portability. Thanks to its intuitive folding mechanism, the E-scooter can be folded up in seconds and easily stowed in the trunk or transported on public transport.



MAZDA E-SCOOTER

Delights not only presidents

PEUGEOT

By integrating the Peugeot Micro e-Kick into the trunk of the 3008 SUV, Peugeot and Micro are pursuing a joint urban mobility strategy. The two lifestyle products also form a purist and elegant unit in terms of design. Incidentally, it was the former French President, François Hollande, who was the first to take a look at the world premiere of the hybrid E-scooter at the 2016 Paris Motor Show - he was impressed.



PEUGEOT E-KICK

CORPORATE SCOOTER

Environmentally friendly and space-saving mobility solutions for companies, hotels & events

A growing number of companies are investing in advanced mobility solutions offering both employees and customers optimal transportation options. These solutions serve different purposes - as practical means of transportation between different company locations, as environmentally friendly alternative to company cars or as unique experience for guests.



©: Limmattaler Zeitung

GOOGLE

Google provides its employees in Zurich with around 200 branded Micro Scooters for commuting around the company premises and for lunch outings.



TRAVEL AND EXPLORE

Micro Kickboard USA has entered into an exclusive partnership with Kimpton Hotels & Restaurants, a renowned boutique hotel chain with 74 locations worldwide. The Kimpton team worked with Micro to develop customized Mini Deluxe and Maxi Deluxe Scooters, which are now available to hotel guests at 30 select locations in the US.



MICRO X EXPO DUBAI

As an official supplier, we were able to equip the Swiss pavilion at Expo Dubai with 100 branded Micro Scooters and a Microlino.



25HOURS HOTELS

At the "25hours Hotel Zurich West", hotel guests can rent cars, bicycles and Micro E-scooters. The mobility concept is an opportunity to meet the needs of urban, cosmopolitan travelers.



WATTWORLD SHARING

Docking station with E-scooters, which can be unlocked via app or company card, for traveling between the various company locations.





JOHN LEWIS, OXFORD ST, LONDON UK



POPOP STORE LA, USA



MICRO FLAGSHIP STORE - VILNIUS, LITHUANIA

MICRO DISPLAYS AROUND THE WORLD

Micro products are available in over 80 countries - whether in specialist shops, online or in our flagship stores. Our sales partners around the globe do everything they can to implement our vision of a **"better urban lifestyle"** and the associated Micromobility concept at the point of sale in line with market requirements. We are proud how all our partners always represent Micro as a brand with full vigor and enthusiasm.

Many thanks to all Micro partners!

MICRO DEALER SEARCH



www.micro-mobility.com/en/dealer-locator



MICRO STORE, AMSTERDAM



SHINSEGAE DEPARTMENT STORE GANGNAM, KOREA



MICRO MOVING STORE, ECUADOR



DUFRY, ANECDOTE, ZÜRICH AIRPORT, SWITZERLAND



YOUNG V&A MUSEUM DISPLAY IN LONDON, UK



MICRO FLAGSHIP STORE ZURICH, SWITZERLAND



STARFIELD GOYANG, KOREA

13

TIME SAVING CALCULATOR

Time is precious!

The time saving calculator on micro-mobility.com calculates how much time you save if you travel the "last mile" by Micro Scooter instead of walking.

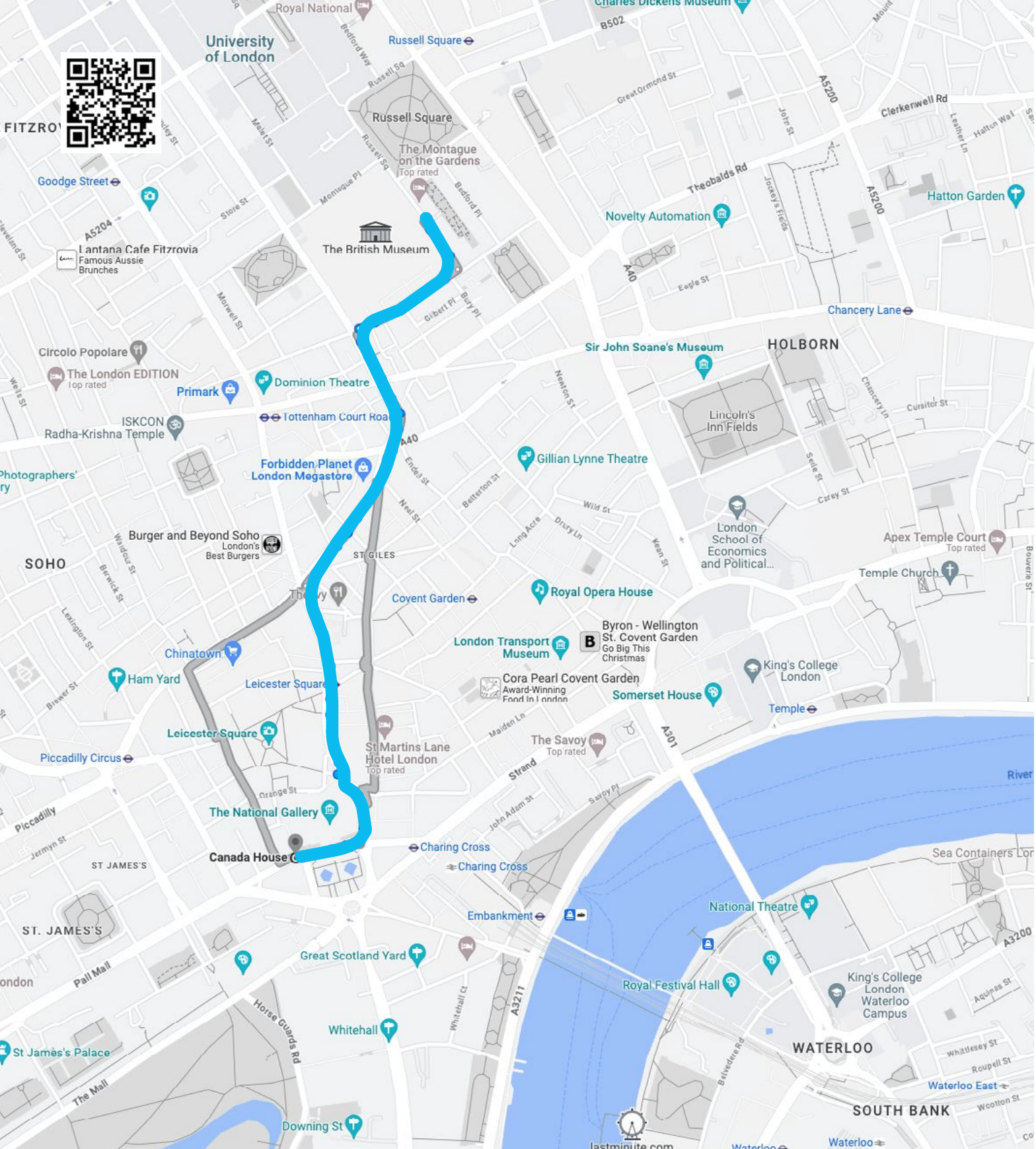

ZURICH: BELLEVUE - ZURICH ZOO

- 19 Films
- 3 Books
- 25 Fitness trainings
- 148 Beers with friends
- 19 Yoga classes
- 74 Dinners

1.52 DAYS

12 HOURS PER YEAR • 720 MINUTES PER YEAR

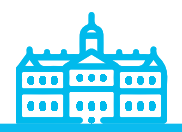

LONDON: BIG BEN - BUCKINGHAM PALACE

- 25 Films
- 4 Books
- 33 Fitness trainings
- 196 Beers with friends
- 25 Yoga classes
- 98 Dinners

2.21 TAGE

49 HOURS PER YEAR • 2940 MINUTES PER YEAR

MICRO SCOOTER SAFETY TRAINING

«That was the coolest morning since I started school! Now I finally know how to brake properly!»

Correct braking needs to be learned. This is why Micro supports safety courses for scooters and kickboards worldwide. In addition to the correct braking technique and safe cornering, the workshops also raise understanding and awareness of the dangers and rules when using these popular means of transportation.



Workshops since 2008



510'000
OVER HALF A MILLION ENTHUSIASTIC PARTICIPANTS WORLDWIDE

Switzerland:
Micro Scooter KIDS DAY

Micro SCOOT SAFE
www.micro-scooters.co.uk/welcome-to-scootsafe

EACH LESSON
LASTS 90 MINUTES



SCOOTER TIPS AND
TRICKS

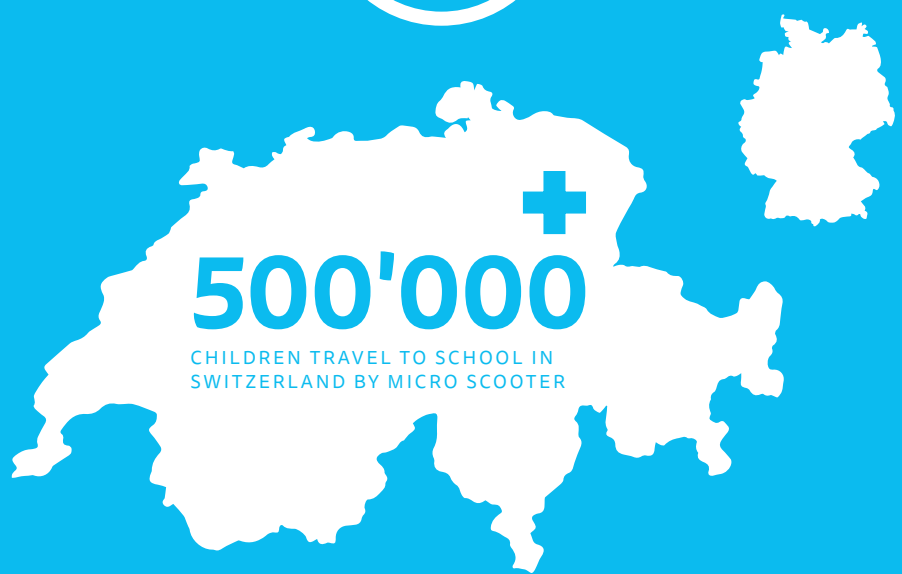

GERMANY: ROLLERKIDS
WWW.ROLLER-KIDS.DE

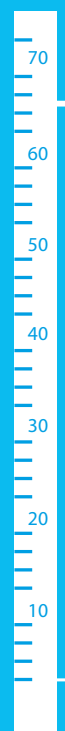

75
THE OLDEST
SCOOTER SAFETY
TRAINING
PARTICIPANT



SCOOTER SAFETY
WWW.MICROSCOOTERS.COM.AU/SCOOTER-SAFETY

4
THE YOUNGEST
SCOOTER SAFETY
TRAINING
PARTICIPANT

FIRST MICRO
KIDS DAY



PRODUCT INNOVATIONS

15



MICRO AIR HOPPER 2



MICRO KICKPACK LITE



MICRO KICKBOARD RELOADED



MICRO FLOOR LIGHT



MINI MICROLINO

WE ARE REINVENTING MOBILITY

Since the foundation of Micro Mobility Systems innovation has been a major part of our corporate DNA. True to our vision of a **"better urban lifestyle"**, we now offer over 50 different mobility products for children, teens and adults and have established

ourselves as the global market leader in the premium segment. Every year, we launch five to seven new products, often breaking new grounds. As a result, we are always one step ahead of our competitors.



MINI MICRO DELUXE GLOW LED



MICRO SCOOTER LUGGAGE JUNIOR



MICRO MINI2GROW DELUXE MAGIC LED



MICRO CLASSIC NEOCHROME BLACK



MICRO GLADIATOR



MICRO SPRITE ECO LED

MICRO COMMUNITY & CELEBRITIES

BECOME PART OF THE MICRO FAMILY!

Space-saving and environmentally friendly Micro mobility or simply "better urban lifestyle" – is our vision. But a vision is worthless without people who believe in it and drive it forward. We are therefore all the happier that our community is growing from day to day. Over 500,000 fans worldwide have already used the hashtag #microscooter have already shown how they live their "better urban lifestyle".

#microscooter



CHRISTIAN BALE AND FAMILY
Daily Mail UK



SARAH JESSICA PARKER WITH KIDS
Daily Mail UK

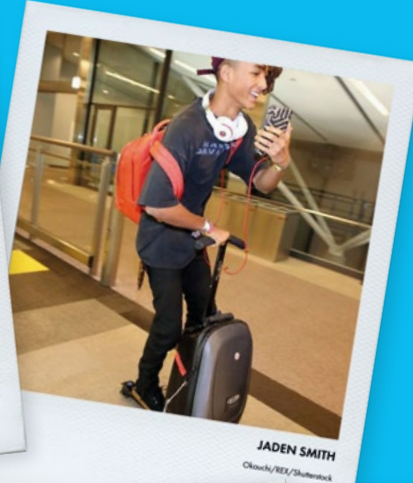

JADEN SMITH
Ok! / REE/Shutterstock



GWEN STEFANI & ANGELINA JOLIE WITH KIDS
www.fox.com



ALESSANDRA AMBROSIO WITH DAUGHTER
Instagram/microscooter_official



PETER DINKLAGE
Daily Mail UK



HUGH JACKMAN WITH KIDS
microscooters.com.au

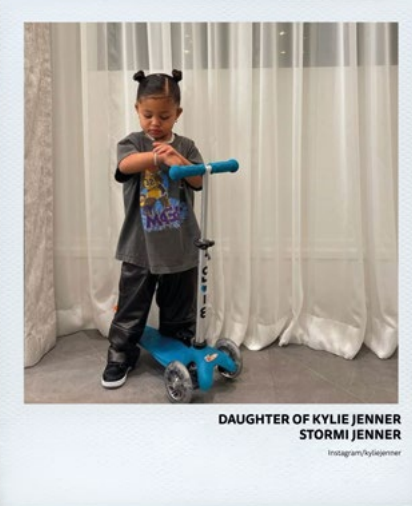

DAUGHTER OF KYLIE JENNER STORMI JENNER
Instagram/kyliejenner



SON OF KIM KARDASHIAN PSALM WEST
Instagram/kimkardashian



CHIARA FERRAGNI
Instagram/microscooter_official



JASON STATHAM
Viewsp.com

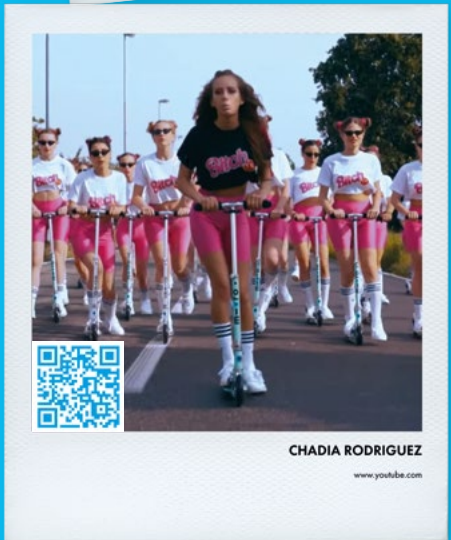

CHADIA RODRIGUEZ
www.youtube.com



DAVID BECKHAM WITH DAUGHTER
FameFlynet.uk.com



LUCAS DI GRASSI
Instagram/lucadigrassi



MARIAH CAREY
Instagram/microscooter_official



KEEP ON RIDING TEAM CHILLI

Since the announcement in 2019, a lot has happened with the acquired Chilli Pro Scooter brand. Chilli is now represented in almost 20 countries, where our partners support the brand in the long term and help Chilli gain international recognition. Thanks to marketing activities aimed at specific target groups, such as cooperation with stunt scooter schools and support for pump tracks, as well as the introduction of appealing and innovative products, Chilli has successfully set itself apart from the competition on an international level. A significant part of our success is due to our rider team, who represent the brand in the best sporting light. The sport is on its way to becoming an Olympic discipline and we are proud that seven of our riders qualified for the 2023 World Cham-

pionships in Sydney, Australia, where they were able to impress with their excellent skills and tricks. In 2023, Chilli Pro Scooter also had the honor of being the official host for the European Championships in Germany as well as the qualifiers. We are looking forward to the further development of this young, up-and-coming brand.

-  @ChilliProScooters
-  @chilliscotersglobal
-  @chilliproscooter
-  www.chilli-proscooter.com



18

Micro Skates

In addition to the successful scooter and kick-board business, we have developed into one of the best-known and most popular inline skate brands in the world. The range includes inline skates and ice skates for all age groups, from beginners to professional models. We also develop accessories such as ice skate bags, clothing and care products. In collaboration with inline skate world champions and top influencers, Micro Skates regularly brings new product innovations onto the market and thereby raises the profile.

www.micro-skate.com

 @micro.skate
  Micro Skate
  @MicroSkate



Faustina Busto on the new 2023 Micro Delta X Freestyle Inline Skates:



Micro & Indiana

UNITED FORCES FOR THE DISTRIBUTION OF SKATEBOARDS AND BALANCE BOARDS

Scooter pioneer Micro and the renowned skateboard brand Indiana will be joining forces from 2023 to internationally promote product development, distribution and marketing of Indiana Skateboards and Balance Boards. The basis of this collaboration is the long-standing friendship between Micro inventor Wim Ouboter and Indiana founder Christof Peller, who both grew up near Lake Zürich. **With over 50 years of combined experience in scooter and board sports, they share a vision - to create a sustainable "last mile of mobility".**

Micro revolutionized urban transportation 25 years ago with the globally successful Micro Scooter. Christof Peller, a passionate board athlete, was one of the first to use snowboard technology for surfing on asphalt. Indiana's skateboards are known for their purist design and were exported to Japan, where they achieved world championship titles and cult status. The balance boards, developed as entertaining sports equipment to promote balance and coordination, complement Indiana's range. Both



companies share important values such as sustainability, innovative spirit and commitment to product quality. Indiana products will continue to be sold under the existing brand name and produced in Europe. Indiana can benefit from Micro's global distribution network in over 80 countries to continue its growth path.

Indiana
SWISS DESIGN SINCE 1989

"With our many years of experience in the field of urban mobility and the knowledge of Indiana, we are able to offer our customers a broader range of sustainable and high-quality products," says Micro founder and CEO Wim Ouboter. Christof Peller, founder of Indiana, adds: "We are proud to work with Micro and bring our products to a wider audience."

indiana-boards.com

 [indianaboards_official](https://www.instagram.com/indianaboards_official)



WIM OUBOTER

AKA MR. KICKBOARD

In 1997, the pioneer and visionary Wim Ouboter reinvented the scooter: his Micro Scooter became a global success and has been an integral part of the world's metropolises ever since. Today, the Swiss entrepreneur is at the forefront of the e-mobility wave and is revolutionizing with his two sons, Oliver and Merlin, the urban mobility of the future. But how does the scooter pioneer live and breathe?



LIFE

Biggest weakness?

Dyslexia

Greatest strength?

Also dyslexia

Dream vacation?

On the island of Paros in Greece

Favorite hobby?

Wing foiling

Morning person or night owl?

Morning person

I do this first thing in the morning...

Bringing my wife, Janine, a cup of tea to bed

Doesn't work at all?

SUVs in the city

Greatest pride?

My two sons

THINGS I LOVE

Books?

The Innovator's Dilemma
by Clayton Christensen

Movie?

Once Upon a Time in America

Music?

Coldplay

Dish?

Bulgogi



THE MICRO REVOLUTION

The origin story of a global brand, told by Micro founder & scooter pioneer Wim Ouboter.



DOWNLOAD THE BOOK!

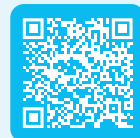

KIDS

THE SOURCE OF MANY CHILDHOOD MEMORIES

Countless kids all over the world grew up with our scooters, let it be on the way to kindergarten, in the schoolyard or in their free time. Our kids products have successfully maintained their strong market position for many years and have been awarded various international prizes. They are also considered educationally valuable toy recommended by doctors. Although Micro products are often copied when it comes to quality, no one can beat them. But what makes us the happiest is that we managed to achieve this with our products, to put a smile on the faces of millions of children and parents.



MICRO AIR HOPPER

Bounce and ride - twice the fun!

Pink
HP0003



18+ Months 

3.1 kg 

25 kg 



MICRO AIR HOPPER 2

Bounce and ride – in a new design!

- Moka HP0005
- Aqua HP0007
- Pink HP0006
- Blue HP0004

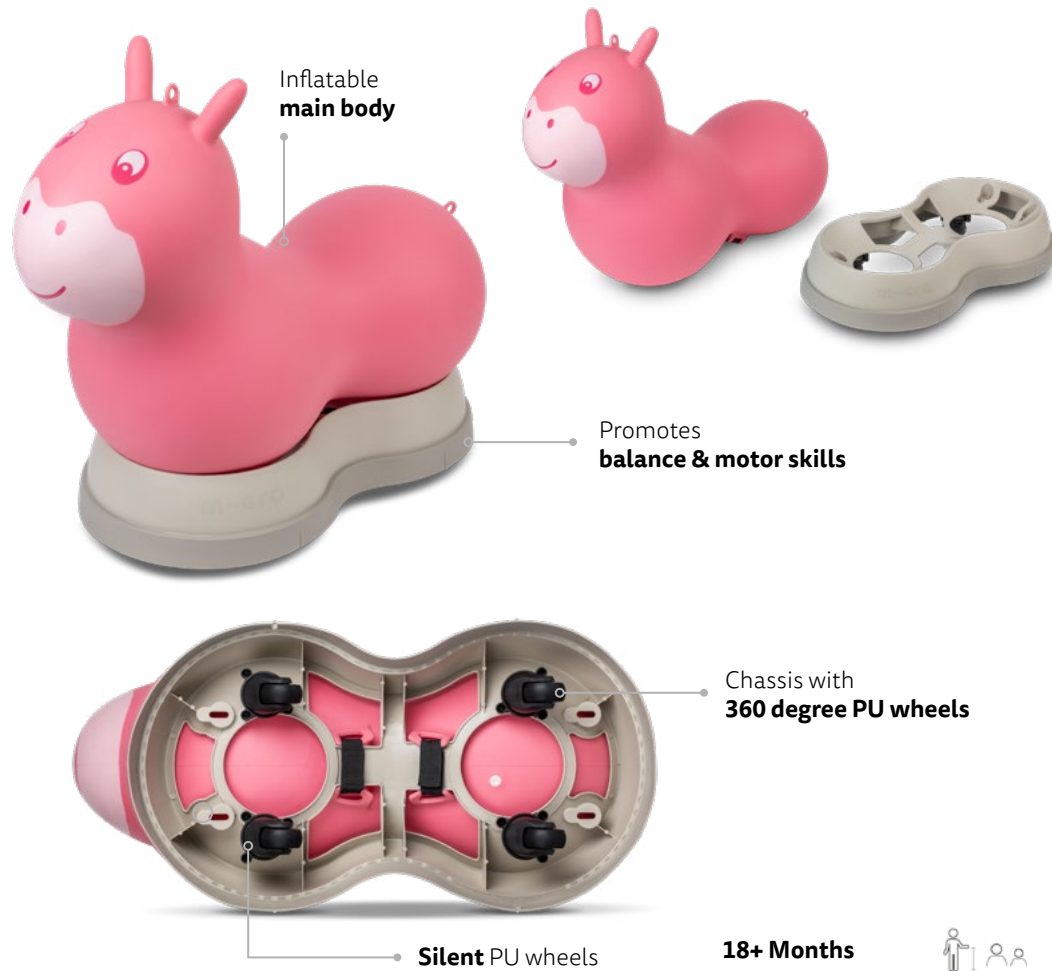

18+ Months 

2.4 kg 

25 kg 



Image is for reference only and may change at any time.

MINI MICROLINO

The mini version of the popular Microlino.

- Blue MC0001
- Mint MC0002
- Pink MC0003



Storage space for toys



Reflector

Self-propelled ride-on vehicle driven by rhythmic handlebar movements

Low seat height for stability and tipping safety



Foam padded seat

Shining headlights

Guaranteed fun indoors and outdoors

Unique Microlino design

18+ Months 

4.3 kg 

50 kg 



MICRO MINI2GROW DELUXE MAGIC LED

All-in-one scooter for the first years of life.

- Red MMD356
- Mint MMD0357
- Blue MMD0358
- Pink MMD0359



Multicolored LED light bulbs for more safety and driving fun

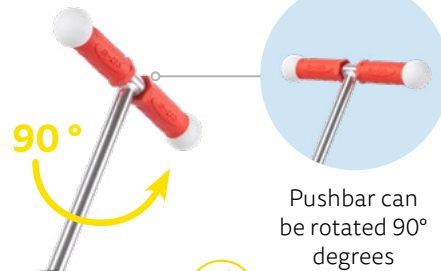

Keyless assembly, no tools required

Removable ergonomic seat



2 removable footrest options

LED moon wheels for better visibility

Lean-to-steer mechanism promotes balance and motor skills

1-6 Years



2.2-3.5 kg



20 kg with seat
50 kg without



Grows with your child.

MINI MICRO 3IN1 DELUXE PLUS LED

Multifunctionality in perfection.

Blue
MMD145

Pink
MMD146



1-5 Years



2-3.1 kg



20 kg with seat
50 kg without



MINI MICRO 3IN1 DELUXE PLUS

Everything from push along to pre-school scooter.

- Pink MMD079
- Blue MMD080
- Ice Blue MMD057



3 Height-adjustable handlebar

Height-adjustable parent steering handle

Height-adjustable seat

Reinforced fiberglass footplate with anti-slip coating

Footrest

Lean-to-steer mechanism promotes balance and motor skills

1-5 Years

2-3.1 kg

20 kg with seat
50 kg without

MINI MICRO 3IN1 DELUXE

The transformation artist deluxe.

- Pink MMD009
- Aqua MMD011
- Blue MMD014
- Purple MMD012
- Red MMD015



O-handlebar for small hands

3 Height-adjustable handlebar

Height-adjustable seat

Reinforced fiberglass footplate with anti-slip coating

Lean-to-steer mechanism promotes balance and motor skills

1-5 Years

2-2.2 kg

20 kg with seat
50 kg without



MINI MICRO 3IN1 DELUXE ECO LED

Multifunctional children's scooter made with recycled plastic components.

NON-LED

- Green MMD161
- Mint MMD163
- Black MMD162

LED

- Green MMD167
- Mint MMD169
- Black MMD168



1 - 5 Years

1.95 - 2.2 kg

20 kg with seat
50 kg without



EXPLORING TODAY
PROTECTING
TOMORROW



MICRO MINI2GO DELUXE PLUS

Multi-tasking wonder, powered by parents.

- Mint MMD031
- Red MMD032
- Pink MMD033
- Blue MMD034



2-5 Years 

1.9-4.2 kg 

20 kg with seat
50 kg without 



MICRO MINI2GO DELUXE

Open the drawer, store the toys and off you go!

-  Mint
MMD017
-  Blue
MMD030



2-5 Years



1.9-3.6 kg



20 kg with seat
50 kg without



MICRO BALANCE BIKE LITE

The featherweight companion for the little ones.

-  Chameleon Blue GB0034
-  Flamingo Pink GB0035
-  Peacock Green GB0036



Height-adjustable saddle

Reflectors

Ultralight magnesium frame

Easy to sit on thanks to the deep frame

EVA foam tires for more comfort

Promotes balance & coordination

2+ Years



2.6 kg



30 kg



MICRO G-BIKE CHOPPER DELUXE

The perfect start to a life on two wheels.

 Pink
GB0023

 Aqua
GB0025



2+ Years



2.9 kg with carver
2.5 kg without



20 kg



MICRO TRAILER

Space for everything you need.

● Black
AC0039



Compatible with all
Mini 3in1-, Mini2go-
& G-Bike-Models

1.6 kg



10 l



MINI MICRO DELUXE FLUX LED

The coolest scooter for little tech fans!

- Red MMD206
- Yellow MMD202
- Neon Pink MMD203
- Neon Yellow MMD205
- Neon Green MMD201
- Navy MMD204



- 2-5 Years**
- 1.95 kg**
- 50 kg**



Mini Micro Deluxe Flux LED Red



Mini Micro Deluxe Flux LED Navy



Mini Micro Deluxe Flux LED Neon Yellow



Mini Micro Deluxe Flux LED Yellow



Mini Micro Deluxe Flux LED Green



Mini Micro Deluxe Flux LED Neon Pink

MINI MICRO DELUXE FLUX LED NEOCHROME

For young techies with a cool neochrome look!

- Pink MMD363
- Navy MMD364



2-5 Years	
1.95 kg	
50 kg	



MINI MICRO DELUXE GLITTER LED

For sparkling adventures.

- Fairy Glitter Pink MMD208
- Fairy Glitter Purple MMD207
- Galaxy Glitter Navy MMD219

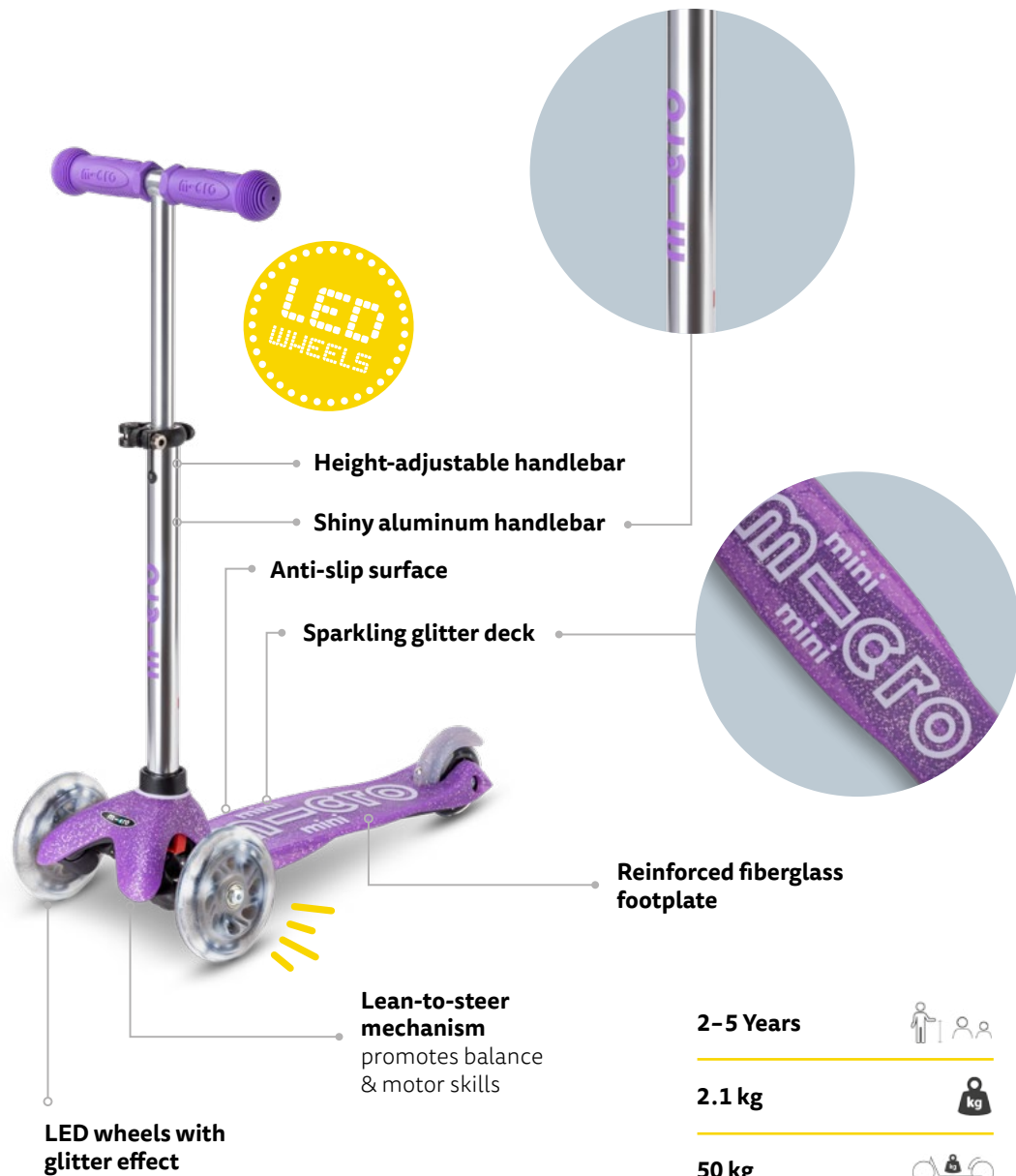

2-5 Years	
2.1 kg	
50 kg	



MINI MICRO DELUXE GLOW LED

Safety plus fun factor.

-  Glacier Aqua MMD218
-  Frosty Pink MMD217
-  Arctic Blue MMD216
-  Icy Lime MMD215



Magic Glow Effect

LED WHEELS
LED wheels for better visibility

Height-adjustable handlebar

Anti-slip surface

Deck, handles, brake and logo glow in the dark



Reinforced fiberglass footplate

Lean-to-steer mechanism
promotes balance & motor skills

No batteries needed

Pastel look in daylight

Lights up in the dark

2-5 Years	
2.1 kg	
50 kg	



MINI MICRO DELUXE GLOW LED PLUS

Magical glow, child's like joy.

-  Glacier Aqua MMD214
-  Frosty Pink MMD213
-  Arctic Blue MMD212
-  Icy Lime MMD211



LED wheels for better visibility

Height-adjustable handlebar

Anti-slip surface

Deck, handles, brake and logo glow in the dark

Reinforced fiberglass footplate

Additional luminosity thanks to motion-activated LED strips

Lean-to-steer mechanism promotes balance and motor skills

2-5 Years



2.1 kg



50 kg



MINI MICRO DELUXE ECO LED

Children's scooter with components made from recycled fishing nets.

- | | |
|--------------|--------------|
| LED | NON-LED |
| Green MMD164 | Green MMD119 |
| Black MMD165 | Black MMD157 |
| Mint MMD166 | Mint MMD158 |



2-5 Years

1.95 kg

50 kg

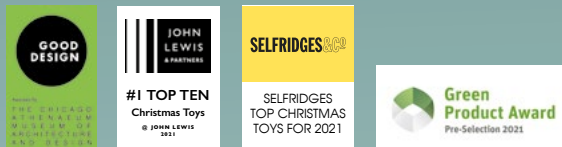

eco



EXPLORING TODAY
PROTECTING
TOMORROW

m-ero



Watch our
YouTube Video

MINI MICRO DELUXE SMART

The Smart Micro Egg takes your scooter experience into the digital age!

Aqua MMD127

Lavender MMD126

Navy Blue MMD128



2-5 Years



1.95 kg



50 kg



INTERACTIVE SCOOTER GAME



More information on our brand page



MINI MICRO DELUXE MAGIC

Magical driving fun on three wheels!

- Aqua MMD131
- Purple MMD129
- Pink MMD130
- Navy Blue MMD149



- 2-5 Years
- 2.1 kg
- 50 kg



Check it out on YouTube



MINILINO

Mini Micro with Microlino Scooter Buddy.

Red
MMD195



2-5 Years

2.2 kg

50 kg



MINI MICRO DELUXE LED

Shine bright like a star!

- Green MMD051
- Yellow MMD053
- Blue MMD142
- Aqua MMD076
- Ocean Blue MMD152
- Navy Blue MMD118
- Purple/Pink MMD173
- Green/Blue MMD174
- Red MMD052
- Pink MMD075
- Purple MMD141
- Lavender MMD150
- Apricot MMD151
- Blue/White MMD176
- Crystal Blue MMD175



2-5 Years

1.95 kg

50 kg



MINI MICRO DELUXE

Everybody's favourite!

- Aqua MMD001
- Pink MMD003
- Yellow MMD005
- Red MMD007
- Lavender MMD037
- Turquoise MMD074
- Navy Blue MMD073
- Green MMD002
- Purple MMD004
- Blue MMD006
- Orange MMD008
- Ocean Blue MMD046
- Ice Blue MMD055



Height-adjustable handlebar

Anti-slip surface

Reinforced fibreglass footplate

Lean-to-steer mechanism promotes balance and motor skills

2-5 Years



1.95 kg



50 kg



LAVENDER MMD037



PURPLE MMD004



ICE BLUE MMD055



AQUA MMD001



BLUE MMD006



OCEAN BLUE MMD046



YELLOW MMD005



TURQUOISE MMD074



ORANGE MMD008



GREEN MMD002



PINK MMD003



RED MMD007

MINI MICRO DELUXE FOLDABLE LED

The classic kids scooter even more compact!

- | LED | NON-LED |
|---|---|
|  Ocean Blue MMD200 |  Ruby Red MMD101 |
|  Purple MMD199 |  Pink MMD156 |
|  Aqua MMD198 |  Purple MMD153 |
|  Pink MMD197 |  Navy Blue MMD154 |
|  Navy MMD196 |  Ocean Blue MMD102 |
| |  Aqua MMD155 |



- LED wheels for better visibility
- Simple folding mechanism
- Reinforced fibreglass footplate
- Lean-to-steer mechanism promotes balance and motor skills
- Height-adjustable handlebar

- 2-5 Years 
- 2.1 kg 
- 50 kg 



MAXI MICRO DELUXE FLUX LED

The scooter for tech fans!

- Purple MMD121
- Blue MMD137
- Aqua MMD138
- Pink MMD139

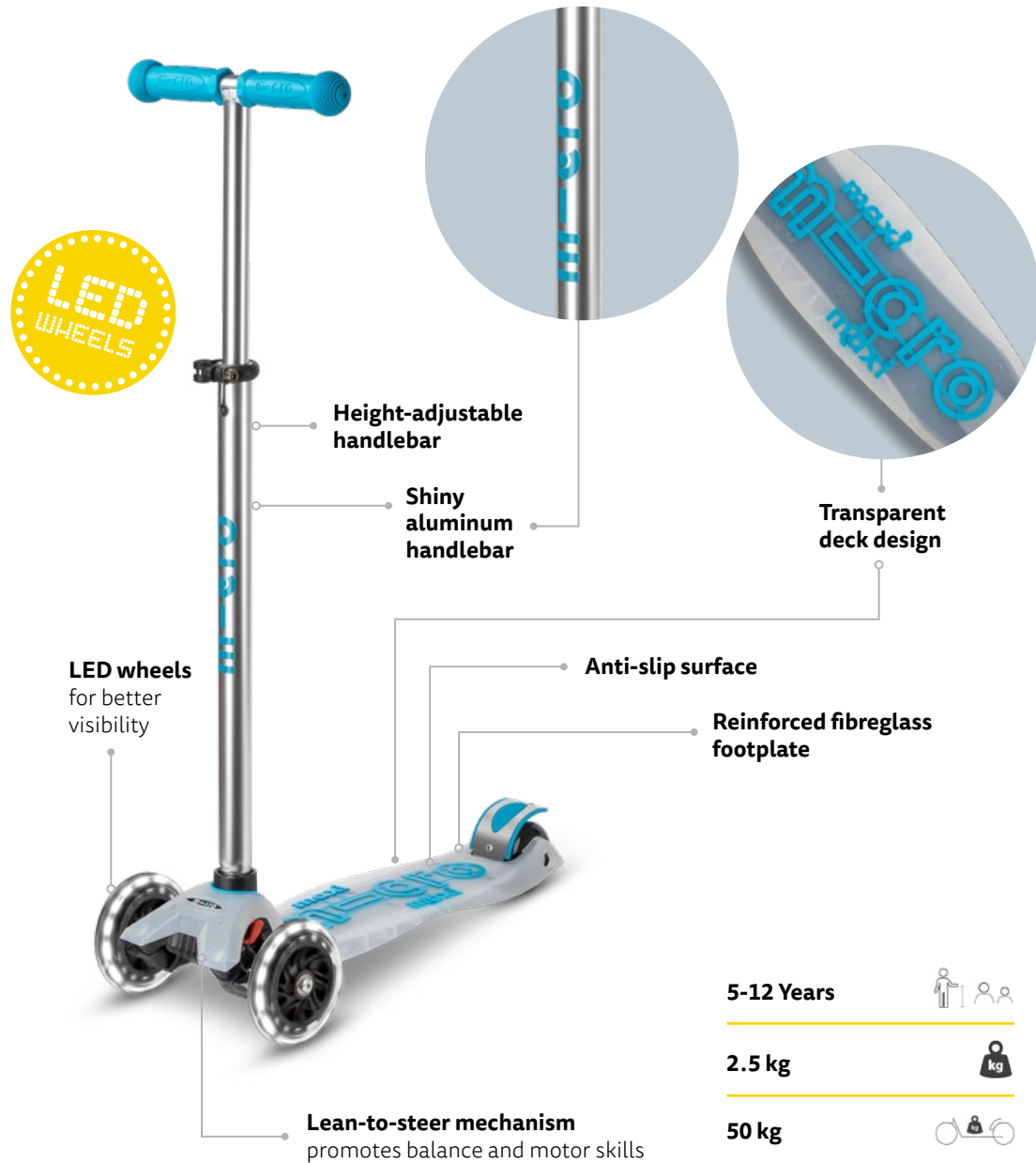

5-12 Years

2.5 kg

50 kg



Maxi Micro Deluxe Flux LED Aqua



Maxi Micro Deluxe Flux LED Pink



Maxi Micro Deluxe Flux LED Purple



Maxi Micro Deluxe Flux LED Blue

MAXI MICRO DELUXE FLUX LED NEOCHROME BLACK

Black
MMD209

The epitome of technological elegance!



5-12 Years



2.5 kg



50 kg



MAXI MICRO DELUXE GLOW LED

Experience the ultimate driving pleasure and radiance

- Petrol Green MMD365
- Aqua MMD366
- Purple MMD367
- Red MMD368



- 5-12 Years

- 2.5 kg

- 50 kg



MAXI MICRO DELUXE ECO LED

Children's scooter with components made from recycled fishing nets.

LED

-  Green MMD170
-  Black/Grey MMD171
-  Mint MMD172

NON-LED

-  Green MMD122
-  Black/Grey MMD159
-  Mint MMD160



5-12 Years 

2.7 kg 

50 kg 



EXPLORING TODAY
PROTECTING
TOMORROW

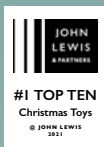

Watch our
YouTube Video!

MAXI MICRO DELUXE FOLDABLE LED

Fold and go!

- Bright Blue MMD092
- Purple MMD100
- Volcano Grey MMD094
- Berry Red MMD095
- Shocking Pink MMD096
- Petrol Green MMD097
- Red MMD098
- Navy Blue MMD099
- Navy/Red MMD133



LED wheels
for better visibility

Height-adjustable handlebar

Simple folding mechanism

Reinforced fibreglass footplate

Anti-slip surface

Lean-to-steer mechanism
promotes balance and motor skills

5-12 Years



2.8 kg











50 kg



MAXI MICRO DELUXE LED

Maximum luminosity on three wheels.

-  Purple MMD066
-  Red MMD068
-  Aqua MMD078
-  Mint MMD144
-  Caribbean Blue MMD085
-  Blue MMD067
-  Pink MMD077
-  Navy Blue MMD083
-  Black/Orange MMD143
-  Blue/White MMD132



5-12 Years 

2.5 kg 

50 kg 



MAXI MICRO DELUXE

Ride to school independently.

-  Pink MMD021
-  Blue MMD023
-  Shocking Pink MMD035
-  Blue/White MMD132
-  Green MMD022
-  Yellow MMD024
-  Red MMD026
-  Lavender MMD134



5-12 Years 

2.5 kg 

50 kg 



MAXI MICRO DELUXE PRO LED

For the cool kickboarders.

- Sunburst Yellow MMD041
- Vibrant Blue MMD042
- Rose MMD135
- Purple MMD043
- Black/Red MMD135
- Pink MMD040
- Navy/Red MMD044





- 5-12 Years
- 2.9 kg
- 50 kg





MAXI MICRO DELUXE PRO

Even more driving pleasure.

-  Purple MMD091
-  Rose MMD090
-  Grey/Green MMD089
-  Grey/Aqua MMD088
-  Black/Red MMD087



- 5-12 Years** 
- 2.9 kg** 
- 50 kg** 



MICRO CRUISER LED

Cruiser feeling with extra glow.

-  Blue SA0197
-  Pink SA0198
-  Aqua SA0199
-  Neochrome SA0240



5-12 Years	
4.5 kg	
100 kg	



MICRO CRUISER

For the ultimate cruiser experience!

- Blue SA0168
- Red SA0169
- Pink SA0170
- Black SA0201
- Purple SA0202
- Aqua SA0203



- 5-12 Years**
- 4.5 kg**
- 100 kg**





MICRO SPRITE DELUXE

Revival of a well-known classic.

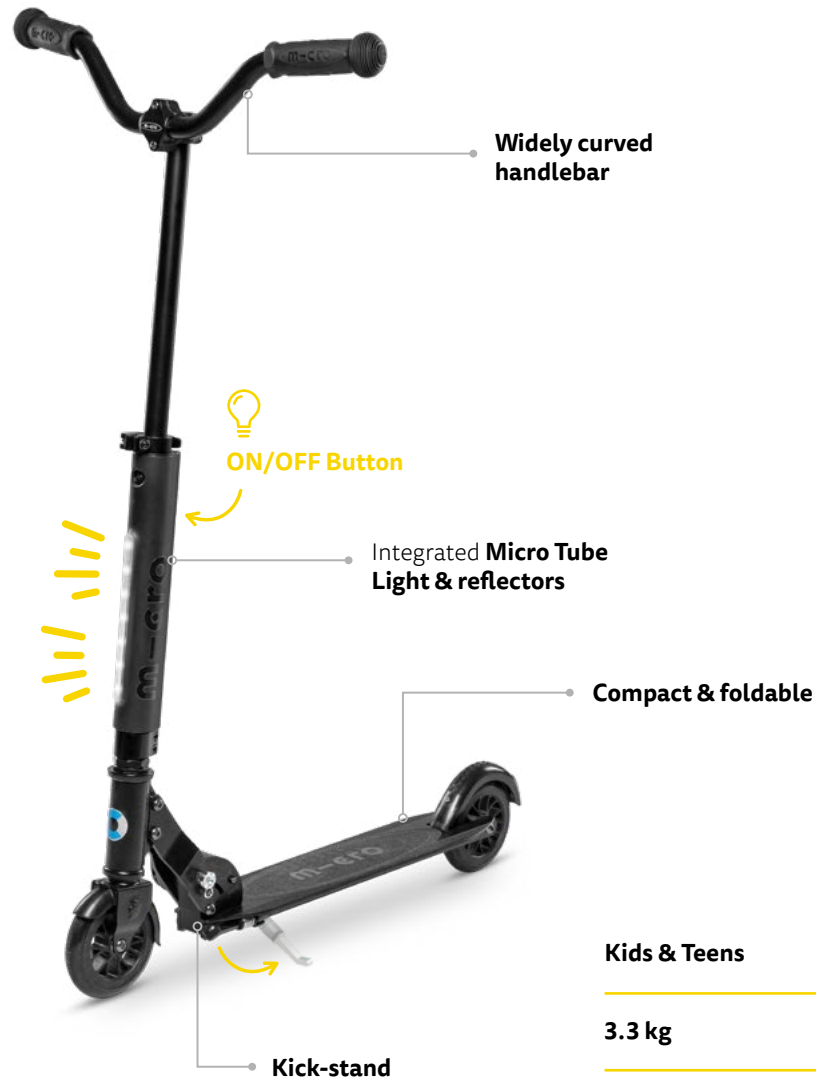
- Black SA0200
- Neon Rose SA0229
- Mint SA0228



Kids & Teens 

3.3 kg 

100 kg 



MICRO SPRITE LED NEOCHROME BLACK

Black
SA0243

The timeless aluminum scooter with a breathtaking black neochrome look.



Kids & Teens

3 kg

100 kg



MICRO SPRITE ECO LED

Your contribution to a sustainable future on two wheels!

Green
SA0250



MICRO SPRITE LED PEARL

The ultimate scooter for style-conscious adventurers!

- Blue Purple SA0293
- Green Purple SA0294



Kids & Teens



3.1 kg



100 kg



MICRO SPRITE LED

The classic aluminum scooter with extra sparkle.

- Silver Matt SA0216
- Ocean Blue SA0210
- Autumn Red SA0209
- Forest Green SA0208
- Pink SA0226
- Blue Stripe SA0217
- Black SA0225
- Purple Stripe SA0219
- Chartreuse SA0224
- Petrol Stripe SA0218
- Sapphire Blue SA0231
- Neon Rose SA0235
- Neochrome SA0237



Kids & Teens



2.9 kg



100 kg



MICRO SPRITE

The Classic.

-  Silver Matt SA0019
-  Oasis Blue SA0024
-  Red SA0025
-  Black SA0026
-  Pink SA0027
-  Sapphire Blue SA0084
-  Black Stripe SA0133
-  Purple Stripe SA0137
-  Floral Dot Raspberry SA0136
-  Red Stripe SA0178
-  Blue Stripe SA0177
-  Purple Metallic SA0132
-  Petrol Stripe SA0179



Foldable handles

Lightweight aluminum frame

Compact & foldable

Kick-stand

Kids & Teens



2.9 kg



100 kg



ADULTS

SCOOT YOUR COMMUTE

Micro Scooters not only make children's hearts beat faster, but they are also very popular with adults. Perfect for short distances in inner-city traffic, such as from the train station to work or university, they can easily be combined with public transport. With us, everyone will find the right scooter, depending on their individual needs and intended use. Our product range extends from the compact Micro Speed to the high-end Micro Suspension with front and rear suspension. All of our scooters have three things in common: functionality, attractive design and unmatched quality.

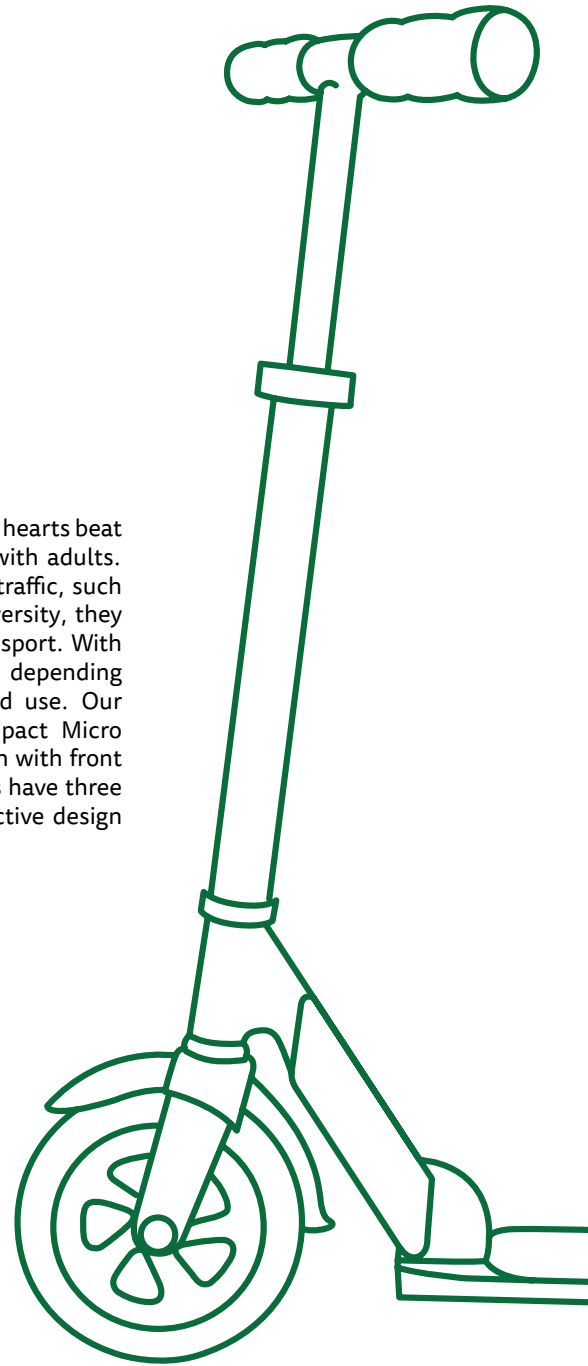

MICRO NAVIGATOR

State-of-the-art technology packaged in a timeless retro look!

Black/ Silver
SA0232



Check it out on YouTube



MICRO SPRITE SUSPENSION

The famous classic
with a new twist.

- Dark Grey SA0245
- Olive Green SA0246
- Light Blue SA0247
- Pink SA0248



MICRO SUBURB RELOADED

Urban driving fun newly defined.

Silver SA0249



6.2 kg 

100 kg 



MICRO METROPOLITAN DELUXE

The cozy allrounder.

- Black SA0212
- Micro Metropolitan Deluxe Black (without handbrake) SA0188



MICRO SUSPENSION

No bumps, no shaking – just a smooth ride!

- Bronze SA0065
- Black SA0156



200 mm wheels

Front & rear suspension

Foldable

Wide deck

Kick-stand

6.1 kg



100 kg



MICRO CLASSIC NEOCHROME BLACK

The versatile urban companion in an elegant black neochrome look!

Black
SA0242



MICRO CLASSIC

A timeless companion for both him and her.

- White SA0031
- Black SA0034
- Neochrome SA0049
- Matt Silver SA0241

NEW COLORS COMING SOON



4.7 kg 

100 kg 



MICRO FLEX 200 MM

Comfortable driving fun.

Black Matt SA0119



MICRO EAZY

Form follows function.
Foldable within a second!

Black
SA0155



Folded up, it can be pulled like a trolley

4.9 kg



100 kg



MICRO SPEED DELUXE

The discreet eye-catcher.

- Clay SA0211
- Alaskan Blue SA0214
- Neon Rose SA0213



4.5 kg







100 kg



MICRO SPEED

The sprinter.

-  Dolphin Grey SA0033
-  Aztec Black SA0121
-  Mint SA0122
-  Silver SA0142
-  Matt Neochrome SA0244



Shock-absorbing 145 mm wheels

3.8 kg 

100 kg 



MICRO ROCKET DELUXE

For descents with style.

Neon Rose
SA0233

Alaskan Blue
SA0234



MICRO ROCKET

The downhill specialist.

● Green
SA0032

● Sky Blue
SA0143

● Black
SA0048



3.9 kg



100 kg



MICRO KICKBOARD RELOADED

Cruising on three wheels.

Black/Grey
KB0025



Wide front wheels for more stability

Widely curved handlebar

Height-adjustable handlebar

Auto-regenerative wheel with back light

Lean-to-steer mechanism promotes balance and motor skills

3.5 kg



100 kg



KICKBOARD ORIGINAL 2.0

Surf the sidewalks!

Alu
KB0024



MICRO KICKBOARD MONSTER

The sleek monster.

Black KB0022

Volcano Grey KB0023

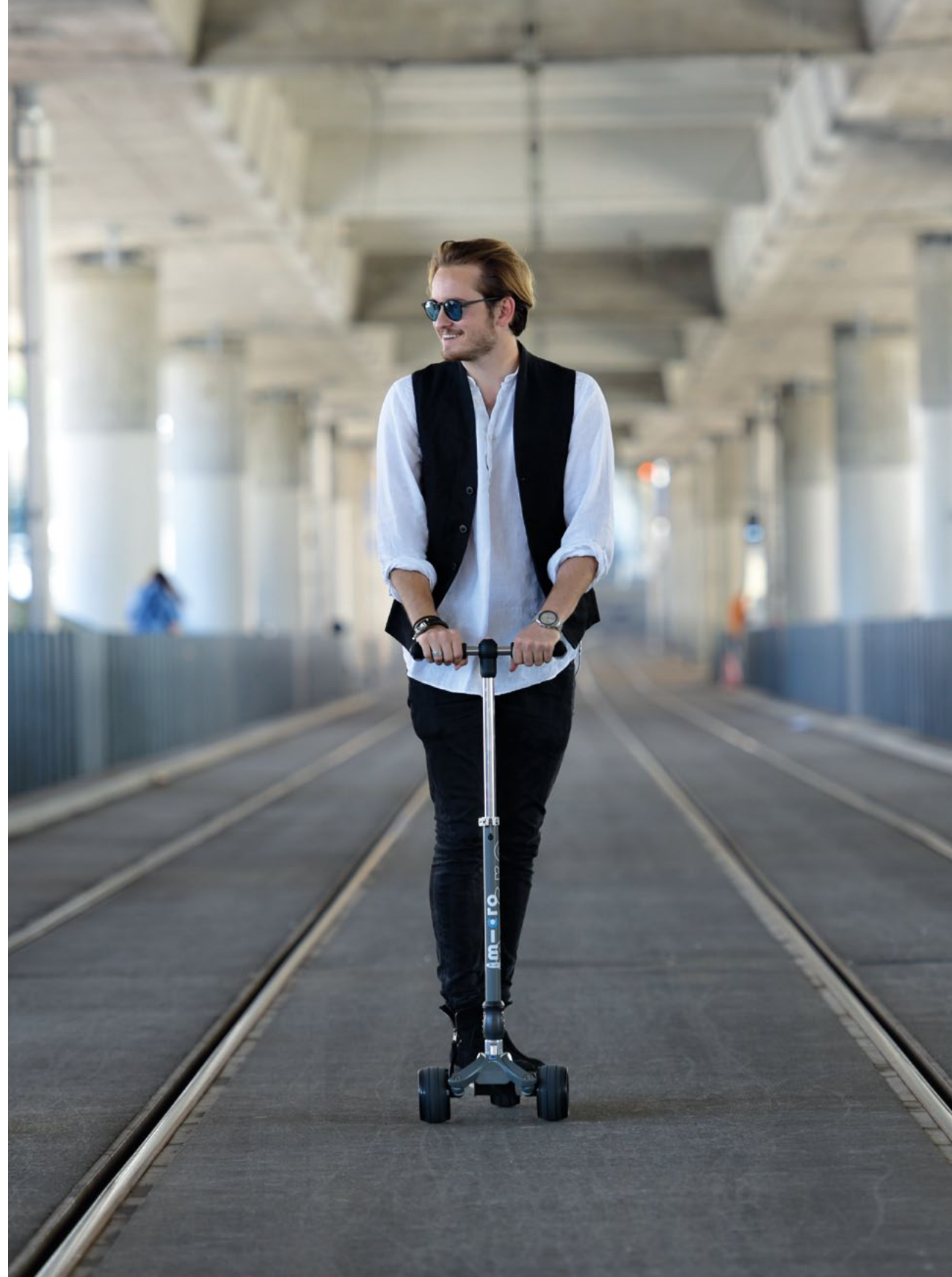

MICRO KICKBOARD COMPACT

Compact & agile, ideal for beginners!

- Silver Matt KB0019
- Black Matt KB0020

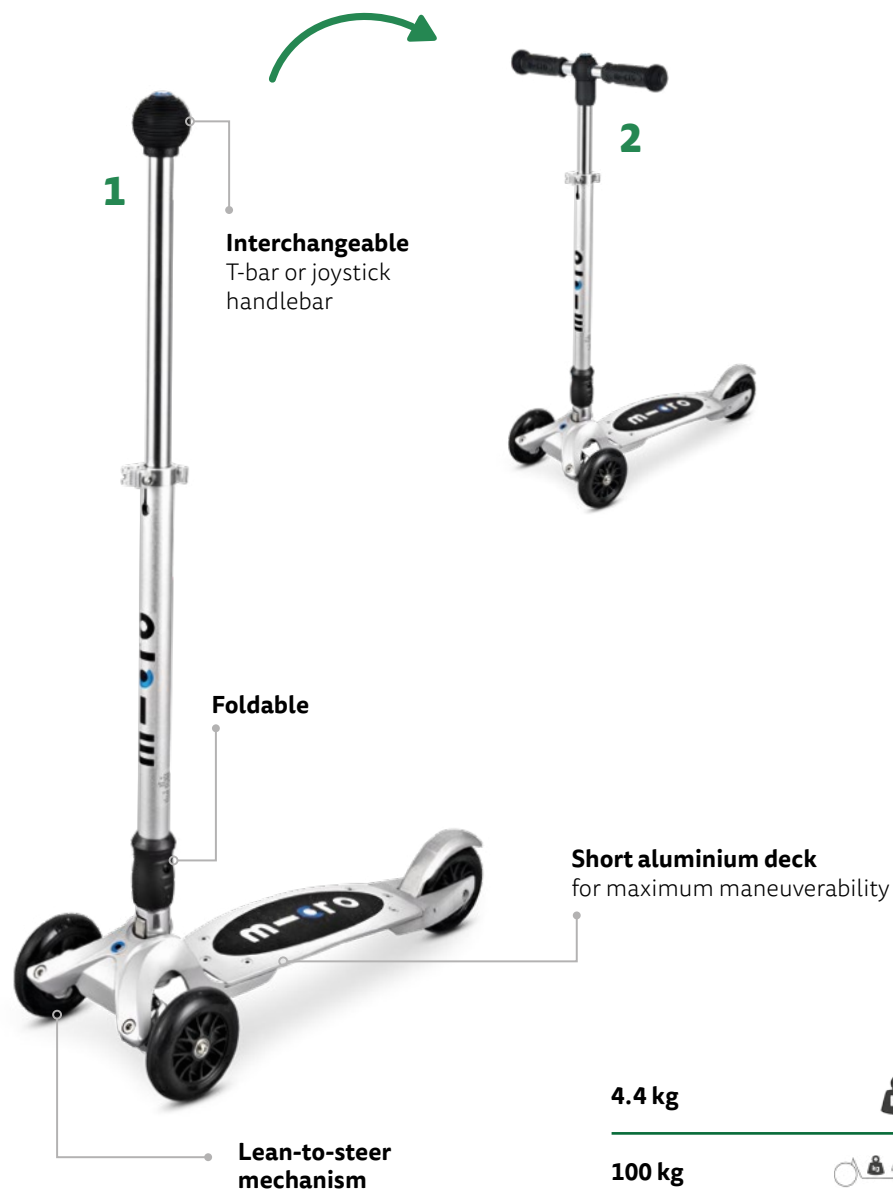

MICRO PEDALFLOW

No time for the gym?
No problem!

○ White
CB0001

● Black
CB0002



8.3 kg



100 kg



reddot design award
honourable mention 2012

ELECTRIC

PREMIUM / X / NICHE

WE ARE ELECTRIC

More and more people live in cities. In many places there is a threat of traffic gridlock, traffic jams and parking shortages are part of everyday life. Air quality is increasingly deteriorating and noise levels are increasing. A mobility transition is urgently needed! True to our vision of a **"better urban lifestyle"**, we have set ourselves the goal of making inner-city mobility more practical and environmentally friendly, without forgetting the fun factor. Our e-scooters are an efficient and flexible way to get around town and are therefore the perfect solution for the "last mile"! The uniqueness of our electric scooters results from the combination of the modern, compact design, light weight, high-tech materials used and the high performance. When developing products in Switzerland, we attach great importance to the seamless integration of the latest, high-quality drive technology.

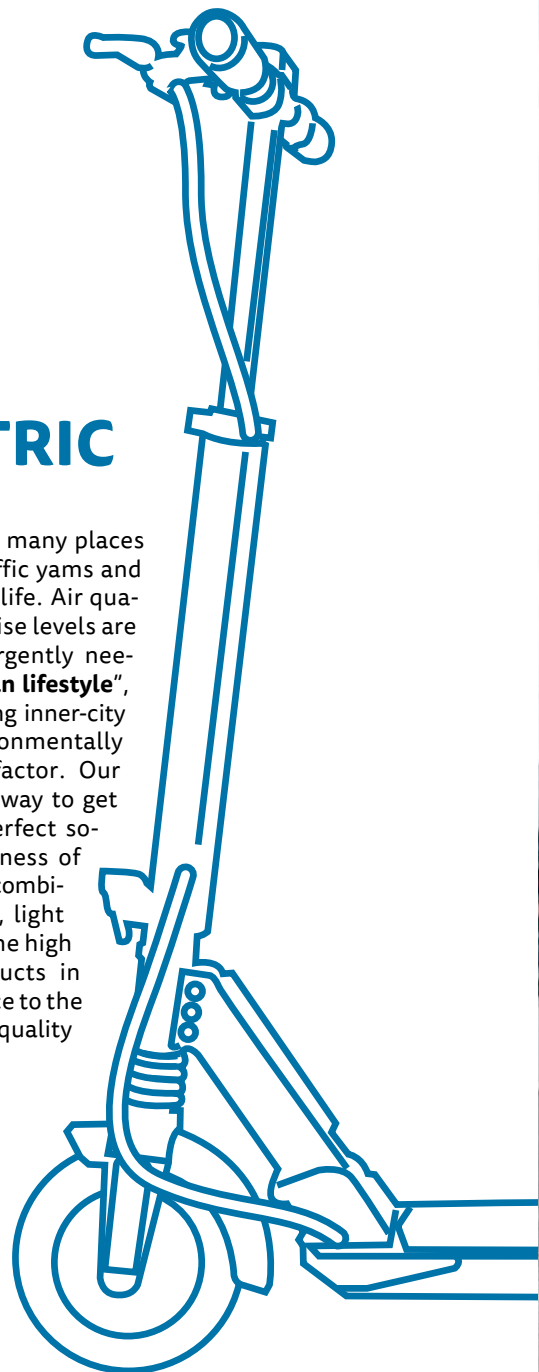



MICRO EXPLORER S

The ultimate powerhouse.

Silver
EM0072 (25 km/h)
EM0076 (20 km/h)



- 14 kg 

- Nom. 450 W
Max. 500 W 

- 40 km 

- Twist throttle 



MICRO EXPLORER II

Long lasting. Powerful.
Wide range.

- Black
- EM0074 (25 km/h)
- EM0081 (20 km/h)



13 kg	
Nom. 350 W Max. 500 W	
35 km	
Twist throttle	





MICRO MERLIN II

The spring loaded long distance runner.

Black/Grey
EM0086 (25 km/h)
EM0092 (20 km/h)



- 13 kg 

- nom. 300 W
max. 500 W 

- 35 km 

- Thumb throttle 



MICRO PREMIUM SERIES

Integrates a mobility solution for the last mile in your daily commute by train, tram, bus or car between home and office.



Micro Merlin II



Micro Explorer II



Micro Explorer S



Power

nom. 300 W
max. 500 W

Range

35 km *

Torque

15 Nm

Hill climbing

15 %

Weight

13 kg

nom. 350 W
max. 500 W

35 km *

17 Nm

16 %

13 kg

nom. 450 W
max. 500 W

40 km *

19 Nm

20 %

14 kg

Braking systems

3

3

3

Tires

200 mm

200 mm

200 mm

App connectivity

no

yes

yes

Double suspension

yes

yes

yes

Foldable handlebar & grips

yes

yes

yes

Display

yes

yes

yes

* ECO Mode



Micro Explorer S

MICRO X11

Comfortable and efficient from A to B.

Ice
EM0094 (20km/h)
EM0096 (25km/h)

Midnight
EM0095 (20km/h)
EM0097 (25km/h)



Integrated Display

Two independent braking systems for absolute safety

App-Connectivity



Electronic lock

Intuitive folding mechanism

Homologated front and rear lights

Thumb throttle



Kick-stand

250mm rubber wheels

18.5 kg



nom. 350 W
max. 500 W



35 km



Thumb throttle



MICRO X30

The powerful long-distance runner.

- Ice
EM0098 (20km/h)
EM0100 (25km/h)
- Midnight
EM0099 (20km/h)
EM0101 (25km/h)



20 kg	
nom. 500 W max. 750 W	
50 km	
Thumb throttle	



MICRO X RANGE

Designed for routes from A to B and longer journeys where comfort and stability are important, like on the way from home to the office, to university or on longer distances through the city



Micro X11



Micro X30



Power	nom. 350 W max. 500 W	nom. 500 W max. 750 W
Range	35 km *	50 km *
Torque	23 Nm	29 Nm
Hill climbing	18 %	25 %
Weight	18.5 kg	20 kg
Tires	250 mm	250 mm
App connectivity ¹	yes	yes
Front suspension	no	yes
Foldable	yes	yes
Display	yes	yes



MICRO COMMUTER

Commuting has never been easier.

Black/White
EM0085



MICRO GLADIATOR

The powerful maneuvering pro!

Silver
EM0069



Front and rear suspension

Large footboard platform for more stability and safety

20 kg



nom. 450 W
max. 500 W



Up to 80 km
(2 battery charges)



Twist throttle



MICROLINO

RETHINKING URBAN MOBILITY

On average, a car carries only 1.2 passengers for a daily distance of 35 kilometers. So driving a big car every day is similar to always dragging your suitcase with you even though you're only going on vacation for a few days. Sounds crazy, right? The Microlino is designed for exactly these 95% of journeys and is not oversized for this purpose like conventional cars. It cleverly combines the advantages of a car with those of a motorcycle and thus turns out to be the iPad of the mobility world. But that's not all, the small city runabout is also significantly more environmentally friendly: Due to its low weight and the small number of components used, it uses 60% less energy during production and while driving.

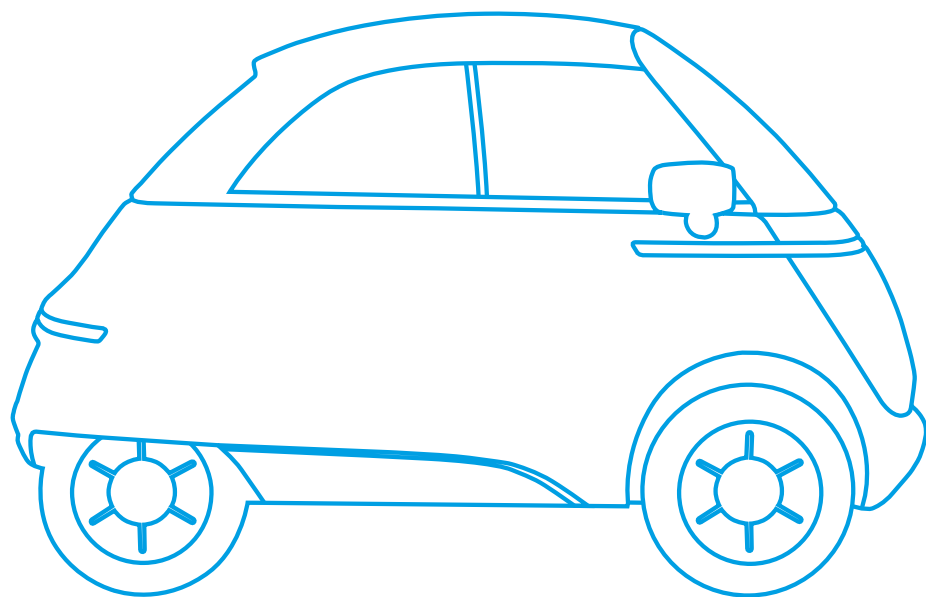

MICROLINO

This is not a car!

The Microlino is the iPad of the mobility world. It combines the advantages of a car with those of a motorcycle. We have equipped the Microlino with everything you need: it has space for two people, three battery options and enough storage space for your shopping. Let's go!

-  Santorini White
-  Paris Mint Bi-Color
-  Amsterdam Orange
-  Berlin Anthracite Matt
-  Zürich Blue Bi-Color
-  London Green Matt
-  Milano Red Bi-Color
-  Gotham Black Matt
-  Barcelona Blue Matt
-  Milano Red



km
Range
93 km / 177 km / 228 km*

Top speed
90 km/h

kg
Weight
435kg (excl. battery)

Battery
5.5 kWh / 10.5 kWh / 15 kWh

Power
12.4 kW

Specifications are preliminary and subject to change at any time.

*Range according to WMTC measuring procedure (World Motorcycle Test Cycle - European standard). The WMTC specification is used to compare the vehicles. In practice, the range may differ significantly depending on riding style, load, topography and season.



Milano Red Bi-Color



Santorini White



Zürich Blue Bi-Color



Paris Mint Bi-Color



Amsterdam Orange



Gotham Black Matt



London Green Matt



Berlin Anthracite Matt



Barcelona Blue Matt



Milano Red



PARKING

CROSS-PARKING RECOMMENDED

The Microlino can be parked sideways with a length of just 2.5 m. Thanks to the front door, you never have any problems getting out, because you step straight onto the sidewalk.



SUNROOF

HERE COMES THE SUN

The standard sliding roof ensures fresh air and a pleasant summer tan. Don't forget the sunscreen! (Excl. Urban Edition)

ENVIRONMENTALLY FRIENDLY

60% LESS ENERGY CONSUMPTION

Thanks to its light weight, the Microlino requires around 60% less energy for production and use than a normal electric car. Not to mention the difference in size compared to a large SUV with a combustion engine.



CHARGING

SOCKET-FRIENDLY

No special charger required! The Microlino can be charged easily and simply in just 4 hours using a normal socket.

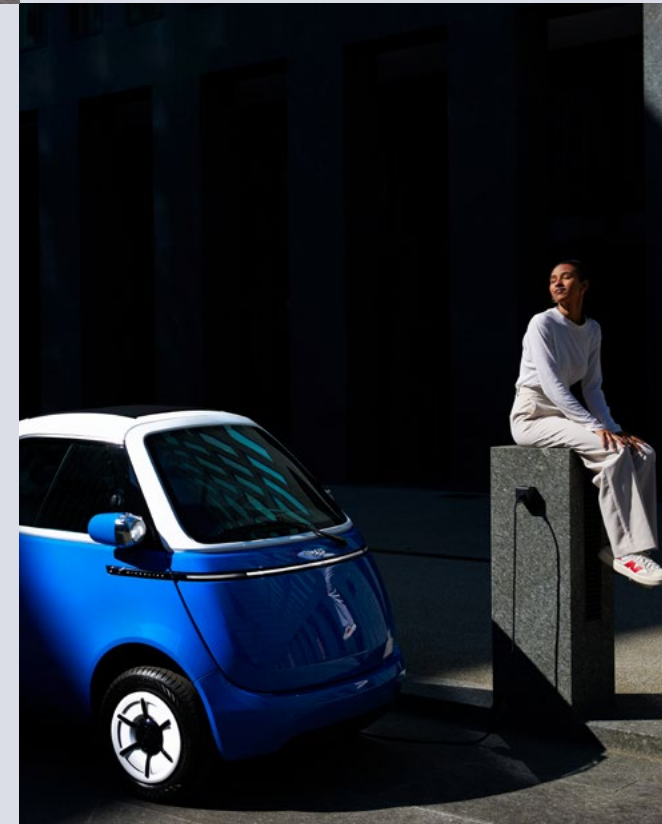

URBAN

ULTIMATE SIMPLICITY

Urban Interior, coupe roof, sport mode, dual displays, LED lights, heating

COLORS

-  Santorini White
-  Amsterdam Orange



DOLCE

A TOUCH OF RETRO

Dolce interior, Infinity LED light bar, folding roof, retro colors & chrome details, vegan leather covered steering wheel, sport mode, dual displays, heating

COLORS

-  Santorini White
-  Amsterdam Orange
-  Milano Red
-  Milano Red Bi-Color
-  Zurich Blue Bi-Color
-  Paris Mint Bi-Color



COMPETIZIONE

THE MODERNIST

Competizione interior, Infinity LED light bar, folding roof, matt colors and chrome details, steering wheel covered with vegan leather, sport mode, LED lights, heating

COLORS

-  Gotham Black Matt
-  London Green Matt
-  Berlin Anthracite Matt
-  Barcelona Blue Matt



TECHNICAL DATA

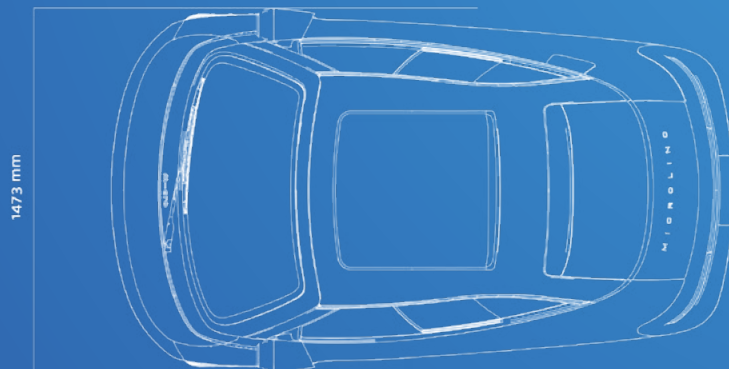
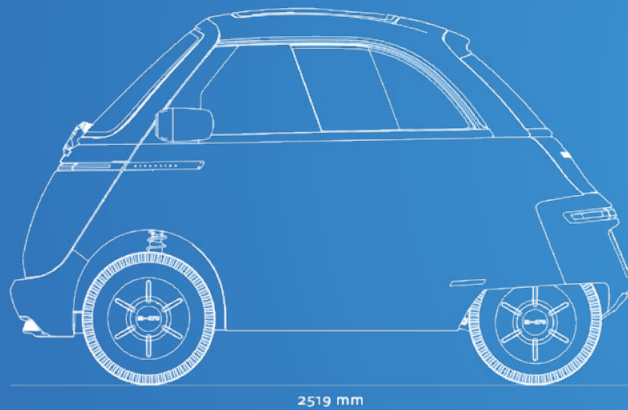
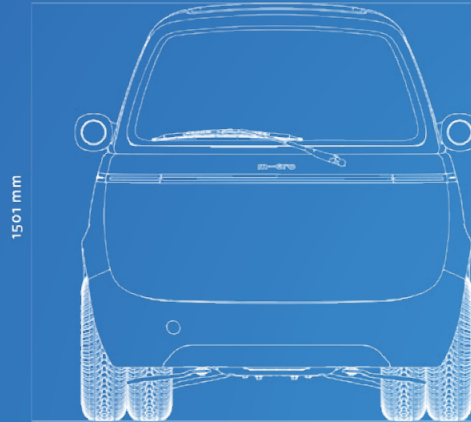

	SHORT RANGE	MEDIUM RANGE	LONG RANGE
BATTERY & CHARGE			
Battery capacity (kWh)	5.5	10.5	15
Battery technology	Lithium-ion (NMC / NCA technology)		
Range WMTc (km)	93	177	228
Charging time with a household socket SOC 80% (h)	3.5	3.5	4.5
Charging services OBC (kW)	1.35	2.6	2.6
MOTOR			
Performance (kW)		12.4	
Consumption (kWh / 100 km)		7.3	
DRIVING PERFORMANCE			
Acceleration 0-50 km/h (s)	5	5	5
Top speed (km/h)		90	
STEERING			
Turnaround place (m)		7.4	
WEIGHT (KG)			
Curb weight without battery (kg)		435	
Empty weight including battery (kg)	586	615	629
Maximum weight allowed (kg)		750	
Payload (kg)	164	135	121
DIMENSIONS			
Length (mm)		2519	
Width (mm)		1473	
Height (mm)		1501	
Wheelbase (mm)		1566	
Front lane (mm)		1250	
Back lane (mm)		930	
Trunk volume (l)		230	
Tire dimensions		145/70 R13 71G	

MICROLINO

Spiaggina

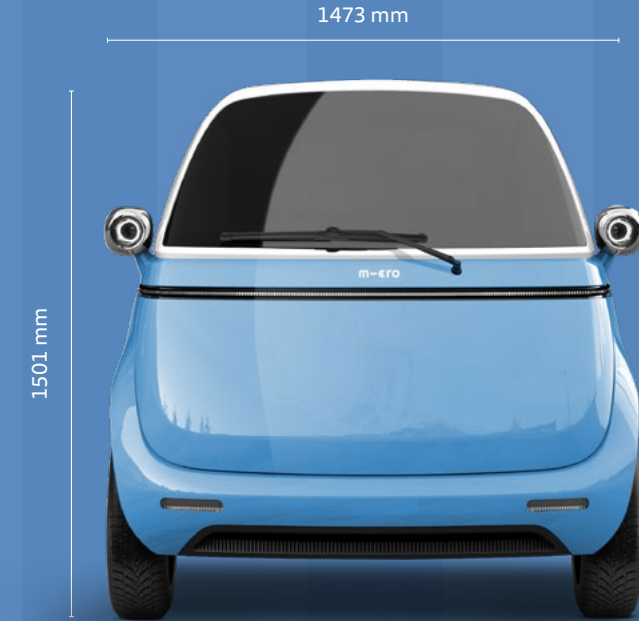

MAX. SPEED
90 km/h



RANGE
93 km / 177 km /
228 km*



CHARGING
4 Hours



POWER
12.5 kW

SUMMER FEELING

The Microlino Spiaggina Concept is inspired by the beach vehicles of the 1960s, such as the Fiat 600 Jolly or the Citroen Mehari. The vehicle has a white and blue striped fabric roof and is completely open on the sides and rear, providing a pleasant breeze and the necessary sun protection in the summer heat.



www.microlino-car.com



2519 mm

Specifications are preliminary and subject to change at any time.

*Range according to WMTC measuring procedure (World Motorcycle Test Cycle - European standard). The WMTC specification is used to compare the vehicles. In practice, the range may differ significantly depending on riding style, load, topography and season.



MICROLINO

— LITE —

ENVIRONMENT-FRIENDLY

The production and operation of the Microlino requires 60% less energy than a conventional electric car.

CHARGING

The Microlino can be easily and simply charged in just 4 hours using a standard household socket.

The Microlino Lite is an L6e version of the Microlino designed for younger customers. It has a similar range to the Microlino, but the top speed is limited to 45 km/h. With the Microlino Lite we want to give even more people access to sustainable mobility solutions. There are more and more people who don't have a driving license and still want to be protected from the weather.

PARKING

The Microlino with a length of 2.5 meters can be parked sideways.



CONCEPT

www.microlino-car.com

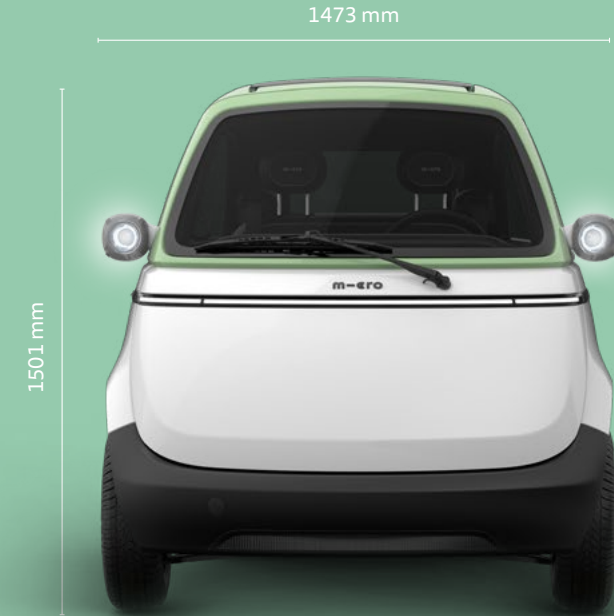

MAX. SPEED

45 km/h



RANGE

93 km / 177 km*



CHARGING

4 hours

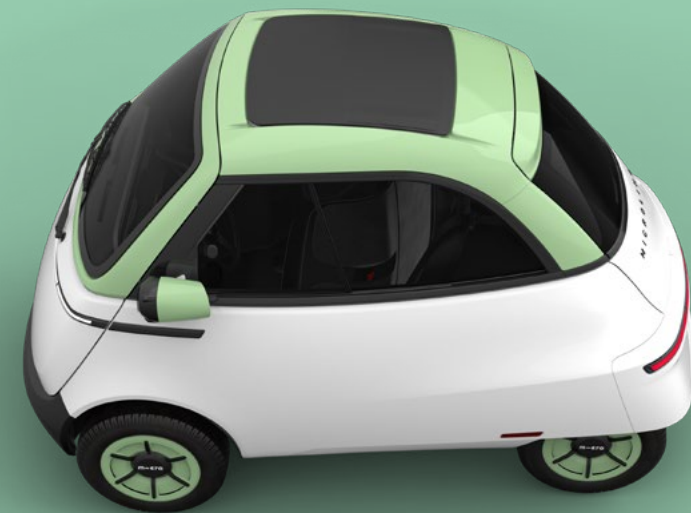

2519 mm

Specifications are preliminary and subject to change at any time.

*Range according to WMTC measuring procedure (World Motorcycle Test Cycle - European standard). The WMTC specification is used to compare the vehicles. In practice, the range may differ significantly depending on riding style, load, topography and season.



HAPPY TRAVEL!

In 2008, we entered the travel business and expanded our product range to include the Micro Luggage, a trolley case with an integrated kickboard, perfect for frequent flyers, travel enthusiasts and business people. A few years later, we received a surprising call from US DJ Steve Aoki, asking us to equip the Micro Luggage with a sound system. This is how the Micro Steve Aoki Luggage Sound2go with integrated Bluetooth sound box was created, designed by Steve Aoki himself. We have developed the Micro Trike and the Micro Luggage Eazy to cater for all age groups, especially the youngest. In line with Micro's guiding vision, our travel products offer practical, uncomplicated and unconventional mobility on the go.

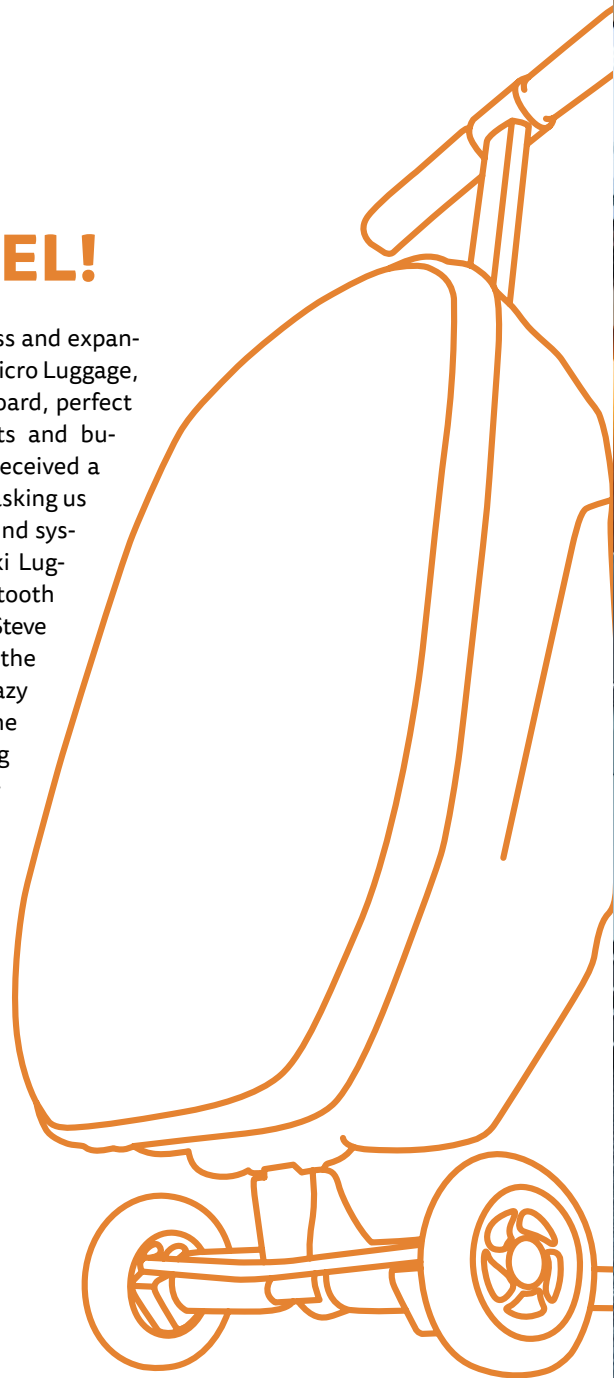

NEW PRODUCTS

COMING SOON



Micro Luggage Eazy Good



Micro Luggage Eazy Better



Micro Luggage Eazy Best



Micro Luggage Eazy Flux



NEW Micro Kickpack Lite



Micro Scooter Luggage 4.0 S



Micro Luggage Eazy Extendable



Micro Luggage Eazy Shopping

MICRO TRICYCLE

Urban elegance, ultimate comfort: refined design, functional craftsmanship.

Matcha TR0021

Latte TR0022



Easy handling and storage: **set up and dismantle in seconds**



Removable roof

Hygienic: **washable cushions**

Backrest with **two different positions (110 / 130 degrees)**

Removable **safety loop**

180 degree rotating seat

Safety with **5-point belt**



Pedals can be used in two different positions and are removable and lockable

6+ Months



8 kg



25 kg



The Micro Tricycle can be gradually converted into a full-fledged tricycle that adapts perfectly to your child's growing needs.



MICRO BABY CRUISER 360°

Safety, comfort, style.
Our Baby Cruiser 360° makes every trip effortless!

Matcha TR0023

Latte TR0024



- 6+ Months
- 7.3kg
- 15 kg

Baby chair for on the go: comfortable eating in the restaurant anytime and anywhere.

Versatile seating options: Adjust the backrest to four different angles and use a 180° swivel seat for a variety of perspectives - effortlessly adapts to your child's needs.

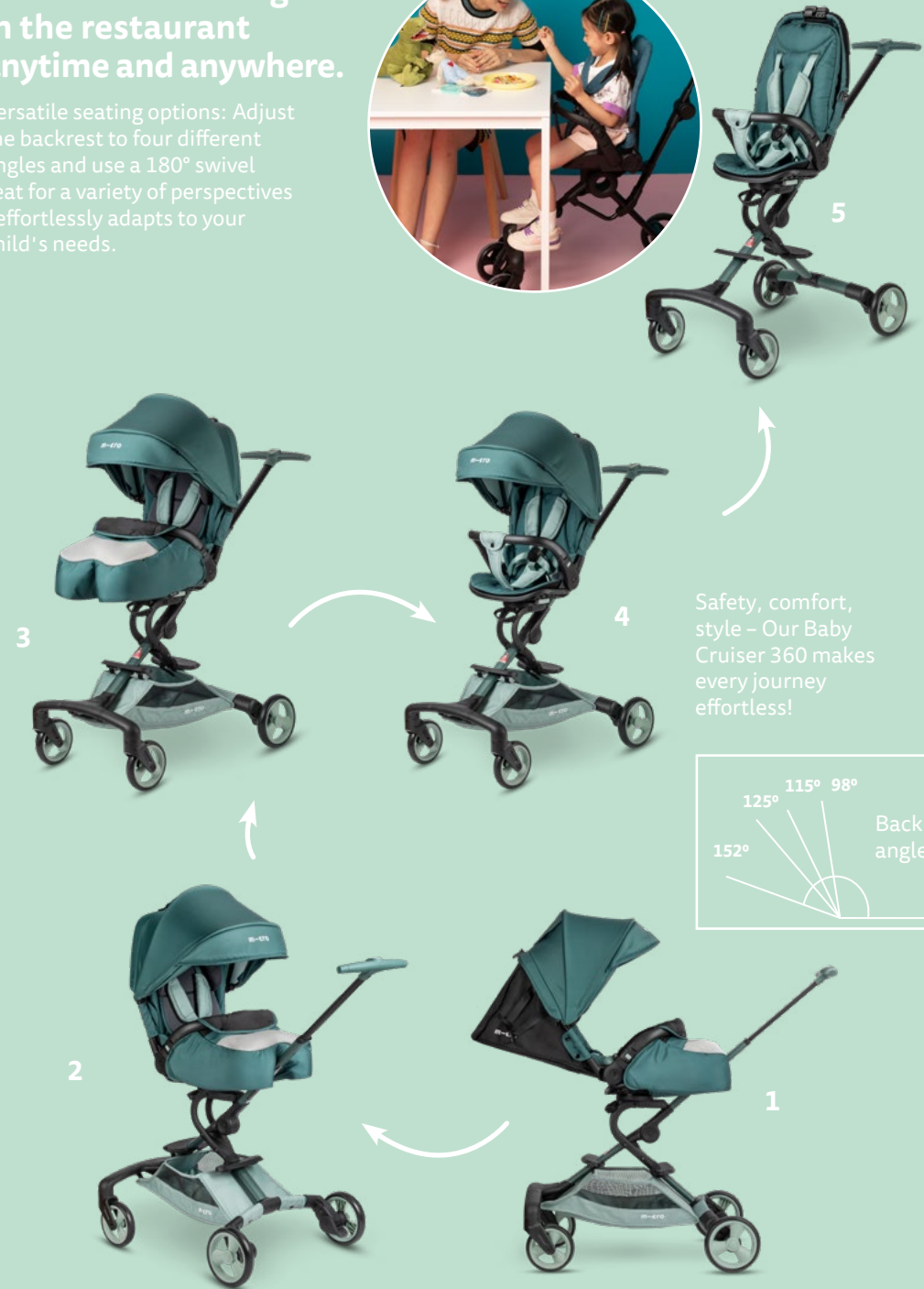

MICRO RIDE ON LUGGAGE EAZY

Suitcase, trolley and buggy in one.

- Black ML0013
- Ocean Blue ML0034
- Forest Green ML0033
- Violet ML0032



Adjustable handle



Hand luggage compatible
(varies depending on airline)

Seat for kids

Folding wheels



Front can be individually designed **with Velcro stickers**

18+ Months



3.9 kg



22 l







20 kg



MICRO TRIKE XL

Ready, set – relax!

-  Ruby Red TR0007
-  Ice Blue TR0008
-  Aqua TR0011
-  Black TR0012
-  Shocking Pink TR0013



Ultra light

Push bar with handle & steering function

1

2

Easily foldable

Height-adjustable footrest

Big wheels for more driving comfort

18+ Months 

1.9 kg 

20 kg 



MICRO SCOOTER LUGGAGE JUNIOR

The practical travel companion for the little ones.

Mint
ML0031

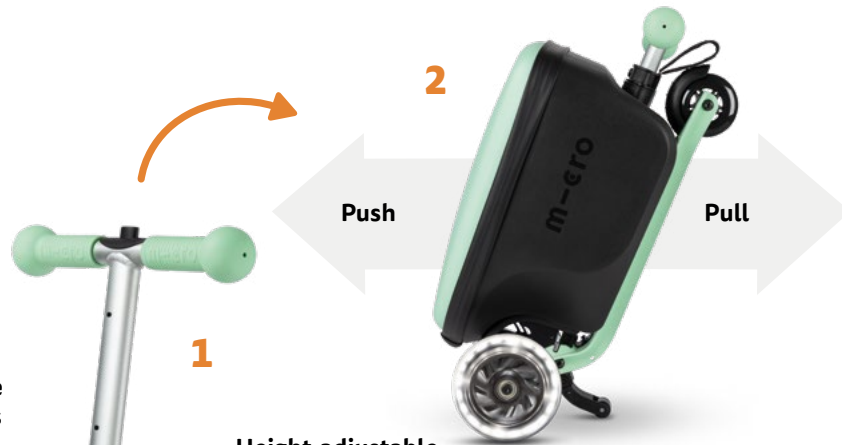

- Storage space for little things
- Height-adjustable handlebar
- Hand luggage compatible (varies depending on airline)
- Easily foldable
- LED wheels for better visibility
- Lean-to-steer mechanism

- 2+ Years
- 3.3 kg
- 13 l
- 50 kg



Available soon - new version with Velcro stickers



Check it out on YouTube



MICRO SCOOTER LUGGAGE 4.0

Trolley and scooter in one.

Black ML0025



6.1 kg



33 l



100 kg



reddot design award winner 2010

MICRO X STEVE AOKI LUGGAGE SOUND2GO

Rock the airports of the world!

Comic ML0007



MICRO WAGON CLASSIC

The family buddy.

Black/Blue
MW0002

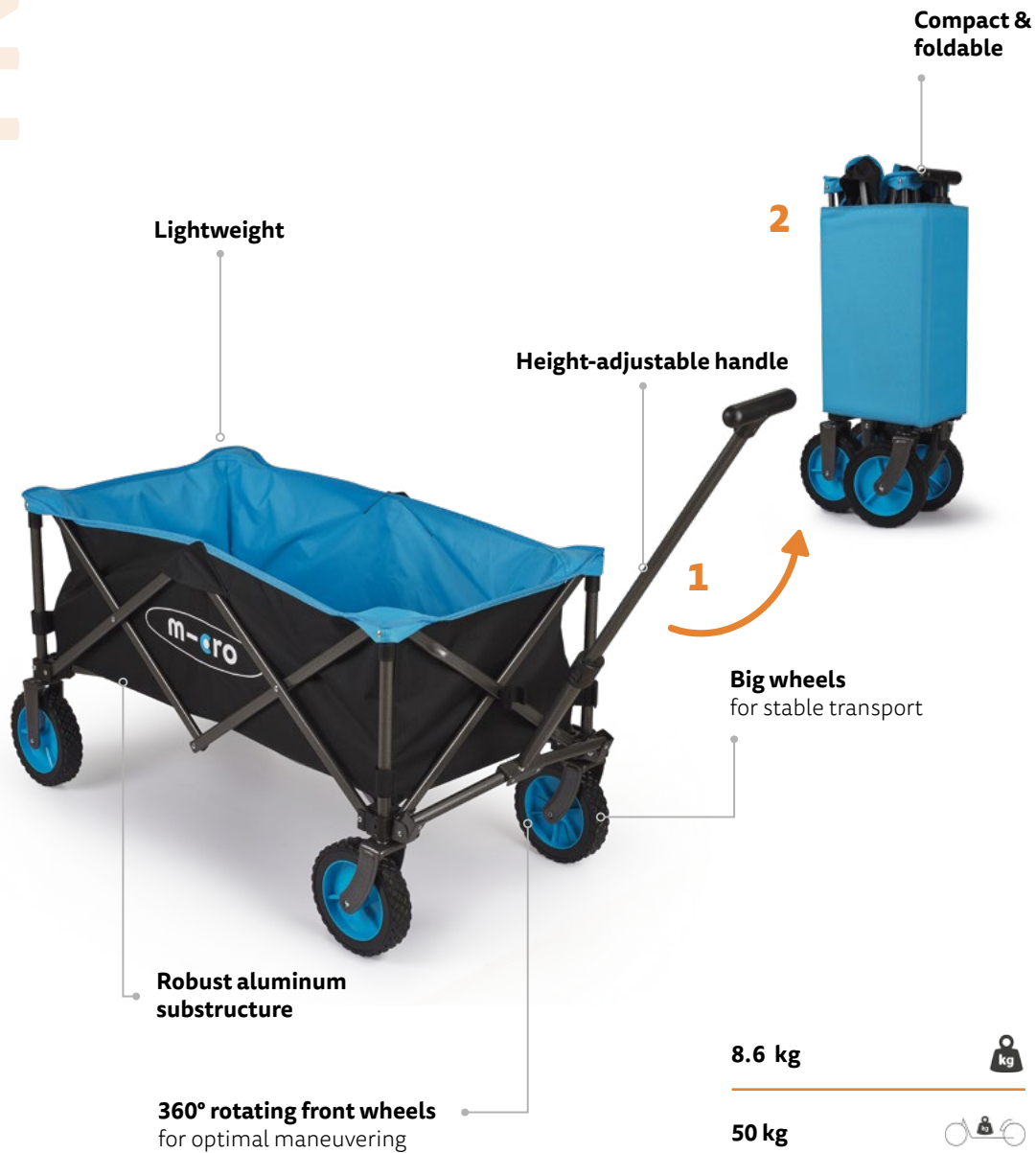

MICRO WAGON DELUXE PRO

The perfect companion for sunny days.

Black/Blue
MW0004



FREESTYLE

FROM UNKNOWN SUBCULTURE TO TREND SPORT

What began as an underground movement in the French-speaking part of Switzerland quickly developed into a worldwide trend. With a variety of breakneck tricks, including double backwards somersaults, a new sport is born. Micro reacted immediately to this trend and developed the first stunt scooter together with riders from Montreux. The Micro freestyle scooters are generating great interest in the scene. Due to the functionality of the products and because Micro takes the feedback & needs of young drivers seriously and integrates them into new development processes.

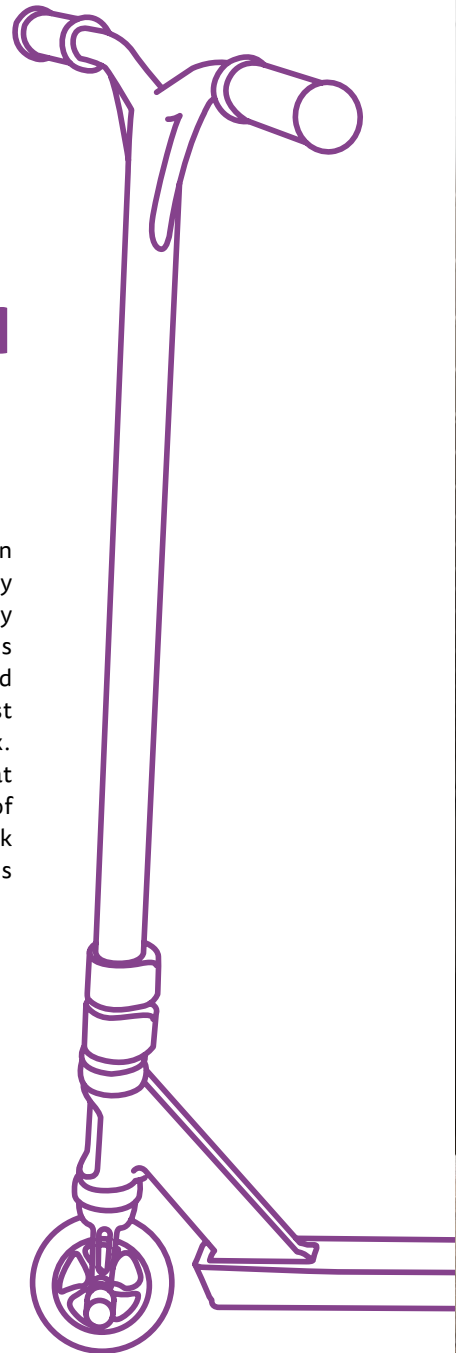

MICRO ICE SNOWPARK

The world's first snow park scooter!

Black SA0140



Wide, one-piece aluminum handlebar

Handcrafted vertical laminated wood core with fiberglass coating

Custom made with polyurea embedded rivets

Double metal runners for directional stability

5.9 kg



55 cm



86 cm



MICRO TROOPER

The street scooter for big stunt scooter fans.

Black/Silver
SA0292



Hybrid Design: Merges stunt scooter functionality with the practicality of a commuting scooter.

Portable and Convenient: T-bar can be easily removed with an allen key for effortless commuting and traveling.

Extra Large Wheels: Equipped with 145 mm wheels, enabling speeds up to 30 km/h.

Increased Height: Overall scooter height of 98 cm for comfortable riding posture.

Enhanced Safety: Features a longer, heat-resistant brake for smooth and safe stopping.

Tall Rider Friendly: Higher set-up and spacious deck cater specifically to taller riders.

4.35 kg	
58 cm	
98 cm	
120 kg	









MICRO STUNT SCOOTER

Our three new stunt scooter models.

- Maverick Grey SA0291
- Supreme Blue SA0290
- Genesis Mint SA0289



	Maverick	Genesis	Supreme	
Weight	3.6 kg	3.5 kg	3.35 kg	
Max. Load	100 kg	100 kg	100 kg	
T-Bar Width	80.5 cm	79.5 cm	91 cm	
T-Bar Height	58 cm	56.5 cm	66 cm	
Handlebar Material	Steel	Steel	Aluminum	
Deck Material	Aluminum	Aluminum	Aluminum	
Wheels	PU and metal core	PU and metal core	PU and metal core	





MICRO TRIXX

Designed with emerging riders in mind!

Black
SA0104

Rainbow Blue
SA0116



3.7 kg	
46 cm	
76 cm	
81.5°	



MICRO RAMP

The perfect scooter for the first tricks.

● Black
SA0190

● Cyan
SA0192



ACCESSORIES

ONLY THE BEST FOR YOU AND YOUR MICRO SCOOTER

Let your creativity run wild and give you and your Micro Scooter an individual look! Our huge selection of colorful and practical accessories ranges from helmets and lights to personal protective equipment and backpacks. Become part of the Micro Urban Lifestyle!



New



Micro Floor Light

AC5466 Micro Floor Light Unicorn
AC5468 Micro Floor Light Rocket

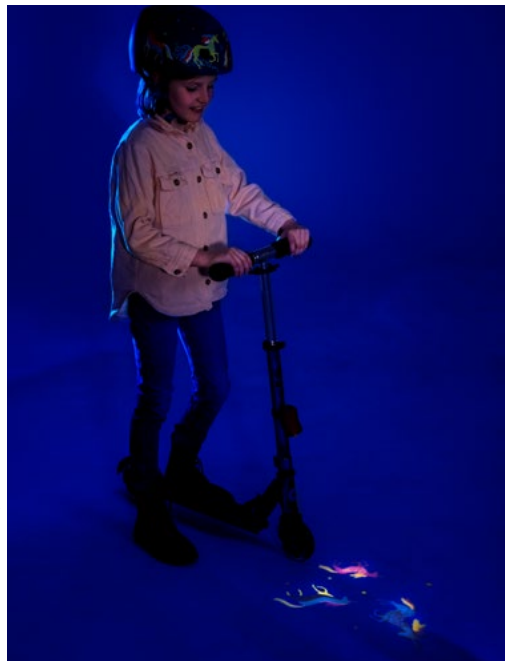
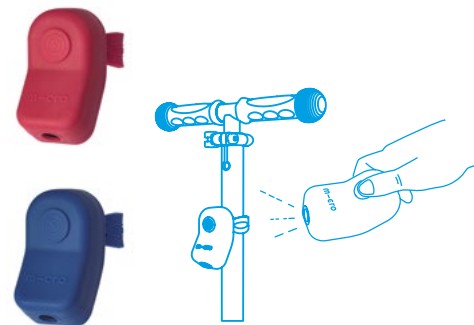

New



Micro Scooter Buddy
Panda
AC4769



Micro Scooter Buddy
Microlino
AC4768



Micro Scooter Buddy
Monsters
AC4763

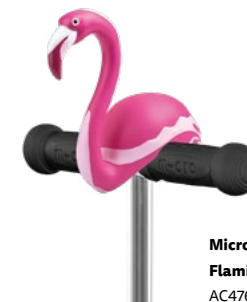

Micro Scooter Buddy
Flamingo
AC4762



New



Micro Mermaid Helmet
AC2283BX (S)
AC2284BX (M)

New



Micro Bell
Neochrome Blue
AC4715



Micro Bell
Neochrome Purple
AC4716



New



**Micro Pull & Carry Strap
Reflective Elastic
Black**
AC4840



**Micro Pull & Carry Strap
Reflective Elastic
Pink**
AC4841



**Micro Pull & Carry Strap
Reflective Elastic
Aqua**
AC4842



New



**Mandala Helmet
Green-Blue**
AC2280BX (M)



**Mandala Helmet
Pink-Purple**
AC2282BX (M)

New



**Micro Knee and Elbow Pads
Reflective Black**
AC5472 (S)
AC5473 (M)



**Micro Knee and Elbow Pads
Reflective Blue**
AC5474 (S)
AC5475 (M)



**Micro Knee and Elbow Pads
Reflective Pink**
AC5476 (S)
AC5477 (M)



New



**Micro Cable Lock
Green**
AC4114



**Micro Cable Lock
Pink**
AC4115



**Micro Cable Lock
Black**
AC3001B



Get-the-Look Rocket



Micro Helmet Rocket
AC2100BX (XS)
AC2092BX (S)
AC2093BX (M)



Micro Knee and Elbow Pads Rocket (S)
AC8023



Micro Light Deluxe Rocket (V2)
AC4129



Micro Bell Rocket
AC4656



Micro Backpack Rocket (XS)
AC4660



Micro Kids Metal Lock Blue
AC4111



Micro Gloves Rocket
AC4830



Micro Windmill Rocket (V2)
AC4750



Micro LED Wheel Whizzer Rocket
AC4811

Get-the-Look Unicorn



Micro Helmet Unicorn
AC2101BX (XS)
AC2102BX (S)
AC2103BX (M)



Micro Knee and Elbow Pads Unicorn (S)
AC8021



Micro Light Deluxe Dark Blue
AC4133



Micro Bell Unicorn
AC4655



Micro Kids Metal Lock Pink
AC4113



Micro Gloves Unicorn
AC4834



Micro Windmill Unicorn
AC4754



Micro LED Wheel Whizzer Unicorn
AC4813

Get-the-Look Scootersaurus



Micro Helmet 3D Scootersaurus
AC2094BX (S)
AC2095BX (M)



Micro Knee and Elbow Pads Scootersaurus
AC8031



Micro Light Deluxe Dark Blue
AC4133



Micro Bell Scootersaurus (V2)
AC4647



Micro Kids Metal Lock Blue
AC4111

Get-the-Look Monsters



Micro Helmet 3D Monsters
AC2116BX (XS)
AC2117BX (S)
AC2118BX (M)



Micro Light Deluxe Red (V2)
AC4129



Micro Bell Monsters
AC4657



Micro Knee and Elbow Pads Monsters
AC8022 (S)



Micro Wheel Whizzers Monster
AC4819

Get-the-Look Doodle Dot



Micro Helmet Doodle Dot
AC2098BX (XS)
AC2086BX (S)
AC2087BX (M)



Micro Light Deluxe Pink
AC4135



Micro Bell Pink
AC4651



Micro Kids Metal Lock Pink
AC4113



Micro Knee and Elbow Pads Doodle Dot
AC8020

Get-the-Look Flamingo



Micro Helmet Flamingo
AC2123BX (S)
AC2124BX (M)



Micro Light Deluxe Flamingo
AC4130



Micro Bell Flamingo
AC4648

Get-the-Look Floral Purple, Toucan, Dragon, Panda & Microlino



Micro Helmet Floral Purple
AC2137BX (S)
AC2138BX (M)



Micro Helmet Toucan
AC2099BX (S)
AC2125BX (M)



NEW
Micro Knee and Elbow Pads Reflective Pink
AC5476 (S)
AC5477 (M)



Micro Light Deluxe Purple
AC4134



Micro Bell Purple
AC4653



Micro Helmet 3D Dragon
AC2137BX (S)
AC2138BX (M)



Micro Helmet Microlino
AC2276BX (S)
AC2277BX (M)



Micro Helmet 3D Panda
AC2269BX (XS)
AC2270BX (S)
AC2271BX (M)

Neon Helmets



Micro Helmet Neon Pink S
AC2272BX



Micro Helmet Neon Blue S
AC2273BX



Micro Helmet Neon Green S
AC2274BX



Micro Helmet Neon Yellow S
AC2275BX

Sprite Uni Helmets



Micro Helmet Red
AC2108BX (S)
AC2109BX (M)



Micro Helmet Ocean Blue
AC2131 (M)



Micro Helmet Autumn Red
AC2129BX (M)



Micro Helmet Forest Green
AC2127BX (M)

Racing Helmets



Micro Helmet Racing White / Red
AC2133BX



Micro Helmet Racing White / Blue
AC2132BX

Youth Helmets



Micro Helmet Stickers
AC2120BX (M)
AC2121BX (L)



Micro Helmet Aqua
AC2115BX (M)



Micro Helmet Black
AC2096BX (M)
AC2097BX (L)



Micro Helmet Headphone Green
AC2111BX (M)



Micro Helmet Headphone Pink
AC2113BX (M)

Raspberry



Micro Helmet Raspberry
AC2080BX (S)
AC2081BX (M)



NEW
Micro Knee and Elbow Pads Reflective Pink
AC5476 (S)
AC5477 (M)



Micro Light Deluxe Pink
AC4135



Micro Kids Metal Lock Pink
AC4113



Micro Bell Pink
AC4651

Smart Helmet

Micro Smart Helmet

AC2134 (M)
AC2135 (L)



remote control

Black



Micro Helmet Black

AC2096BX (M)
AC2097BX (L)



Micro Light Deluxe Black

AC4132



Micro Bell Black

AC4652



Micro Cable Lock

AC3001B



Micro Bottle Holder Black (V2)

AC4694

NEW

Micro Knee and ElbowPads Black

AC5472 (S)
AC5473 (M)



Sunglasses



Micro Sunglasses Unicorn

AC5462



Micro Sunglasses Rocket

AC5461



Baskets



Micro Basket Green

AC4803



Micro Basket Rosa

AC4806



Micro Basket Pink

AC4804



Micro Basket Blue

AC4805

Ribbons



Micro Ribbons Blue Reflective

AC4629



Micro Ribbons Neon

AC4628



NEW

Micro Ribbons EasyShip Neon

AC4139



Additional accessories



Micro Carry Strap, Reflective
 Purple: AC3039
 Black: AC3041
 Red: AC3036
 Aqua: AC3037



Micro Helmet Visor
 AC4138



Micro Vest, Reflective
 AC5460



Micro Bell Royal Blue
 AC4658



Micro Bell Red (V2)
 AC4650



Micro Bell Aqua (V2)
 AC4649



Micro Tube Light
 AC9056 (279mm)
 AC9057 (291mm)



Micro Wheel Whizzer LED Black
 AC4814



Micro Trailer
 AC0039



Micro Ball Net
 AC9055



Micro Trike Net and Cupholder
 AC8050



E-SCOOTER



Range



Motor power



Drive
 (thumb throttle / twist throttle)

SCOOTER



Age range



Max. load



Handlebar height



Weight



Capacity



Handlebar width









Angle



Wheels













AWARDS AND RECOGNITIONS

-  Oppenheim Toy Portfolio – Best Toy Award – Gold Seal
-  Oppenheim Toy Portfolio – Best Toy Award – Platinum
-  Australian Toy Association Award 2015 – Winner
-  Toy Award Nuremberg 2012 – Winner
-  Suisse Toy Award 2012 – Winner Babydreams
-  Reddot Design Award 2009 – Winner
-  Reddot Design Award 2010 – Winner
-  Reddot Design Award 2012 – Honourable Mention
-  Reddot Design Award 2014 – Winner
-  Parents Choice Approved
-  Little London Awards 2016 – Winner: Best Toy
-  Pro-K Product of the Year 2011 – Winner
-  German Design Award 2016 – Special Mention
-  LBP Loved by parents Winner Best Ride on 2011
-  Spiel Gut Award – Recommended





-  Das Goldene Schaukelpferd Nominated
-  Good Toy Award 2009 UK – Gold Award Winner
-  Toy Fair Award 2009 Middle East – Winner
-  Good Toy Award 2007 UK – Gold Award Winner
-  Universal Design Award 2009 Winner
-  Universal Design Award 2009 Consumer Favorite
-  Approuvé par les Familles 2014
-  iF Design Award 2002 – Winner
-  TCS Award 2015 Recommended
-  TCS Award 2015 Recommended
-  Focus Open 2016 Special Mention
-  German Design Award 2010 – Nominated
-  German Design Award Special Mention
-  German Design Award 2012 – Nominated
-  Nursery World Award 2012 Shortlist





AWARDS AND RECOGNITIONS

-  Parent's Choice Award – Gold Award Winner
-  Finalist Lifestyle: Outdoor Gear
-  Winner Best Nuresy: Eco Toys
-  Focus Open 2020 – Special Mention
-  German Design Award 2021 – Special Mention
-  German Innovation Award 2021 – Winner
-  Good Design Award 2020
-  Green Product Award 2021 Pre-Selection
-  Parents' Choice Recommended Award 2020
-  Red Dot Award – winner 2021
-  Top 10 Spielzeug 2021 – Nominated
-  Mums Choice Award Silver 2021
-  Mums Choice Award Bronze, 2021
-  Popsugar Family Awards 2021 Winner
-  Good Design Award 2021

-  Right Start Awards Highly Commended 2022
-  Green Good Design Award 2022
-  Project Baby - Toy Awards Gold, 2022
-  Junior Design Awards Gold, 2022
-  Made for Mums - Toy Awards Silver, 2022
-  Dadsnet - Awards Bronze, 2022
-  UKMUMS.TV Mum's Choice Awards Bronze, 2022
-  UKMUMS.TV Mum's Choice Awards Gold, 2022
-  Kind + Jugend Asean Innovation Award Winner, 2023
-  Go for Gold Silver Award 2023
-  The Travel Retail - Asia Pacific- Award Winner, 2023
-  Travel Retail Awards Highly Recommended by Shoppers - 2023

Micro Mobility Systems AG
 Bahnhofstrasse 10
 8700 Küsnacht
 Switzerland
 info@micro.ms
 www.micro-mobility.com
 www.microlino-car.com

 facebook.com/micro.worldwide
 @microscooter_official
 @microoriginal
 @microscooter_official

 facebook.com/microlino.car
 @microlino_official
 @microlino_official
 @microlino_official

Imprint

The name, logos and Micro products are protected by copyright and are trademarks of Micro Mobility Systems AG, Switzerland. All information in this catalog is without guarantee and replaces all content from previous years. Subject to change without notice.

Concept

Jessica Stingl, Isabelle Ide, Janine Ouboter, Wim Ouboter, Merlin Ouboter, Oliver Ouboter
 Micro Mobility Systems AG

Layout & Design

Nikolett Palinkas, Micro Mobility Systems AG

Photos

Frank Nader
 Thomas Masotti
 Marty | Trezzini
 Simon Habegger
 Serano Brazerol

Print

F&W Druck- und Mediencenter GmbH

Micro recommends wearing a helmet, as well as elbow and knee pads.

Copyright Year 2024
 All rights reserved.

FIND US WORLDWIDE

Find your local Micro representative





Micro Mobility Systems AG
Küsnacht, Zurich, Switzerland
www.micro-mobility.com