



# 509 CREW 509

# 509CREW EXPLORER



N613010



N613011

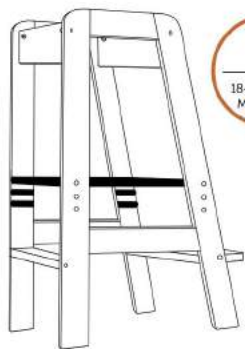

  
18+ MONTHS  
MAX. 50 KG

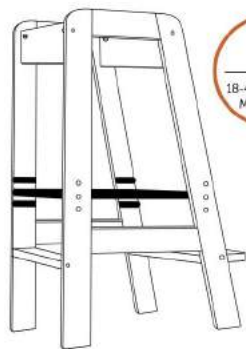

  
18-48 MONTHS  
MAX. 50 KG

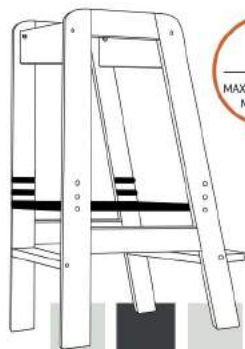

  
MAX. 48 MONTHS  
MAX. 50 KG

*Step up!*

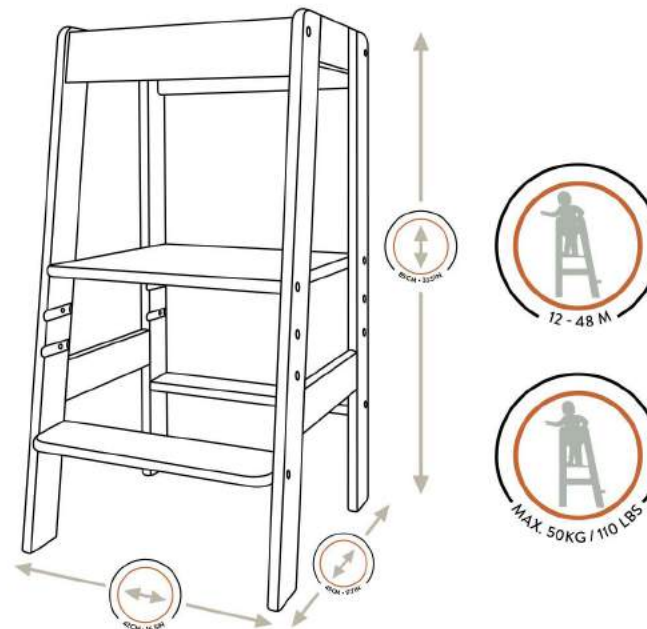



N616011



N616010



*Flip  
Flop!*

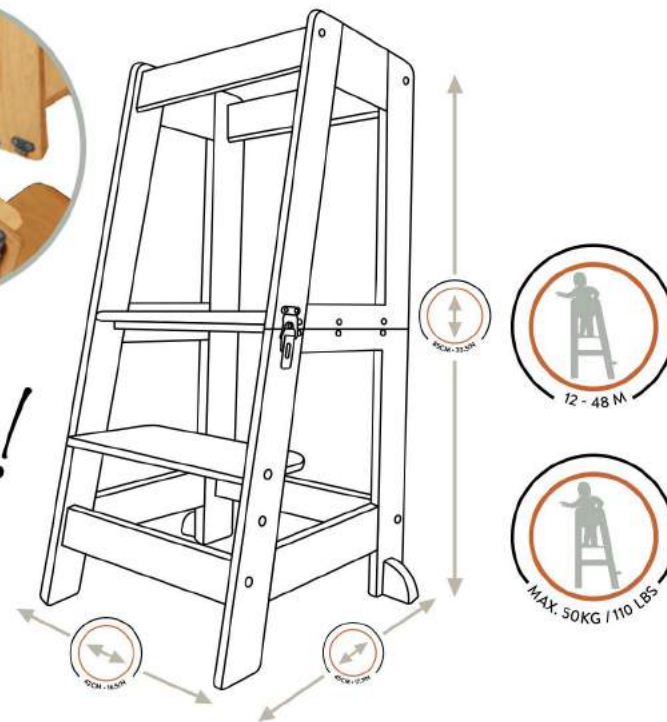



N622011



N622010



*So High!*





N623011



*Step n'  
Slide*



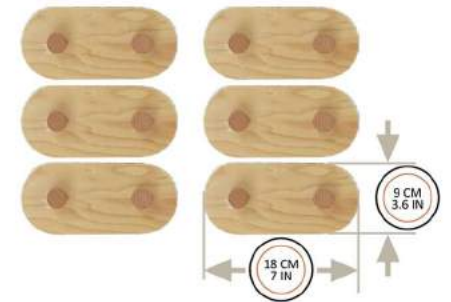
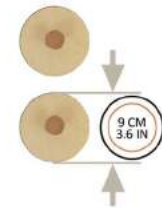
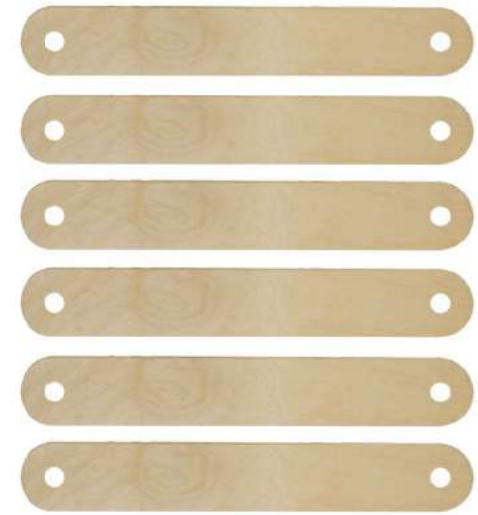

N642011



*and there's More!*



N647011



N645019

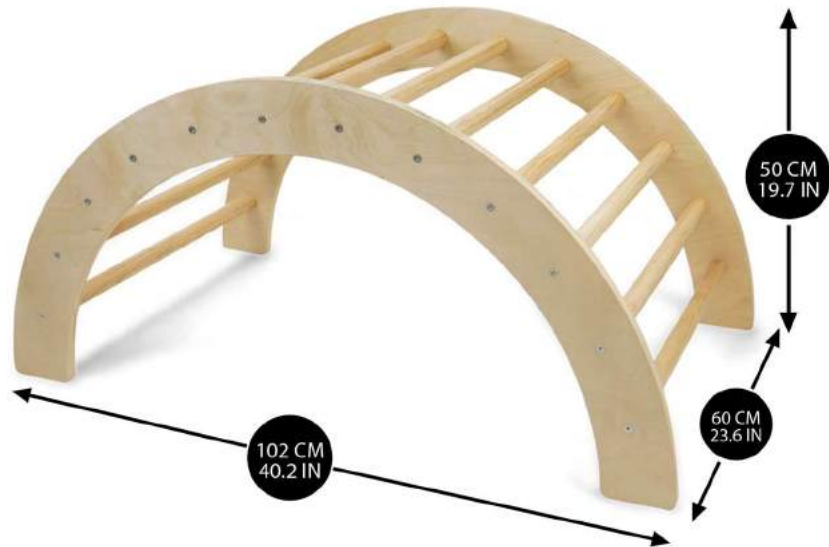

*Relax n'  
Roll!*



N644019



*See you at the Top!*



N654011





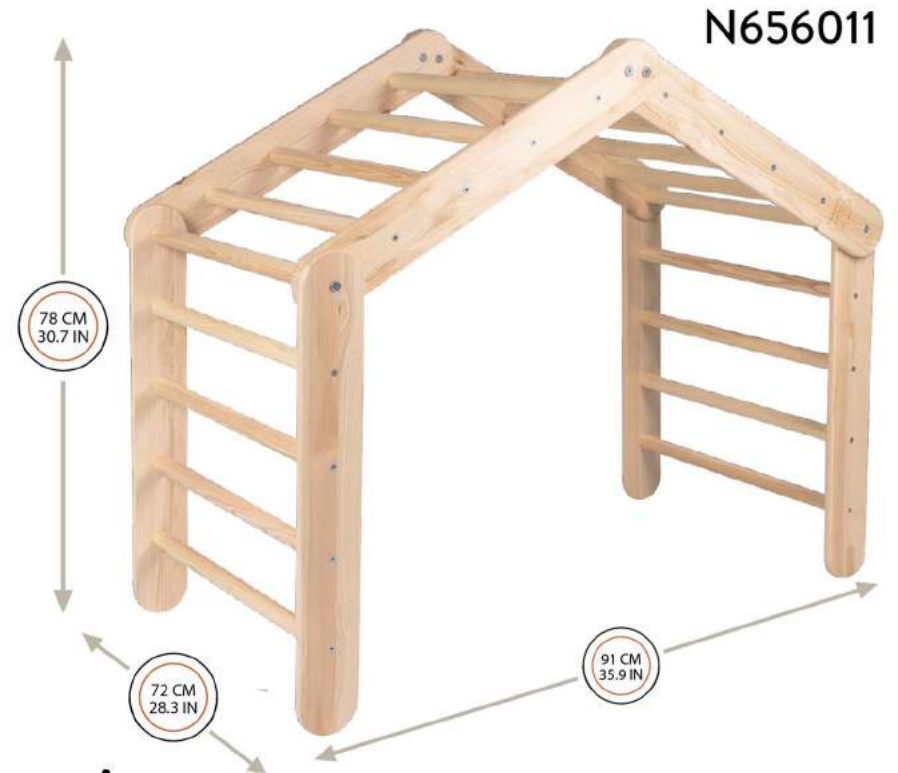

*Welcome!*





*Up n' Over!*

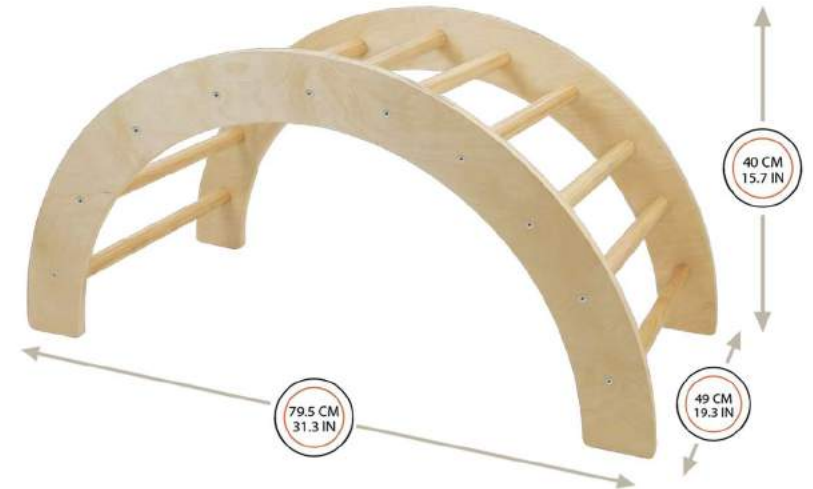

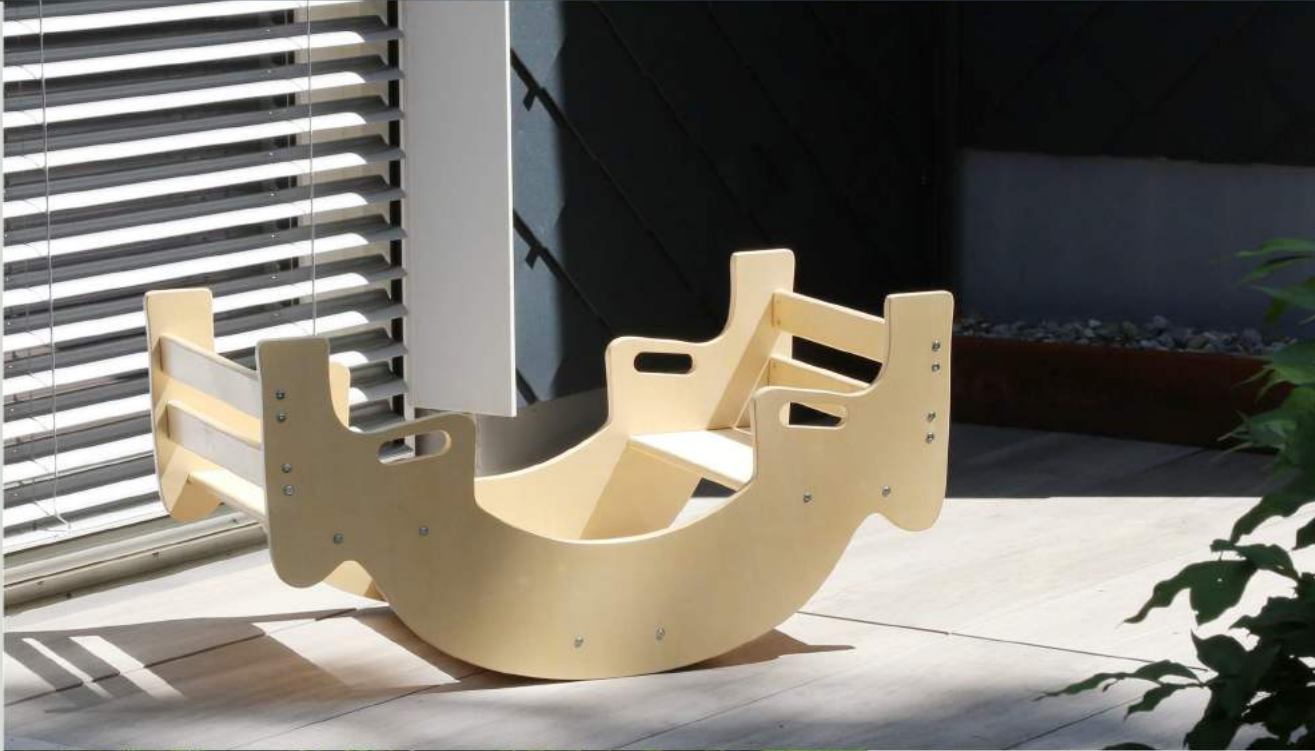

*Boats n'  
Bridges*

N634011

# TRIO CLIMBING TRIANGLE



N655011

- Size 102(L) x 63(H) x 45(W)cm
- 3 Section Climbing Triangle
- Foldable for compact storage
- For child from 3 year +, capacity up to 60kg
- Wood material = solid pine
- Conform to EN71 standard

*Enjoy the little things...*



# 509 CREW 59

IT'S THE LITTLE THINGS

# SKY HIGH CHAIR



N602011



N602010



*The Sky's the Limit!*

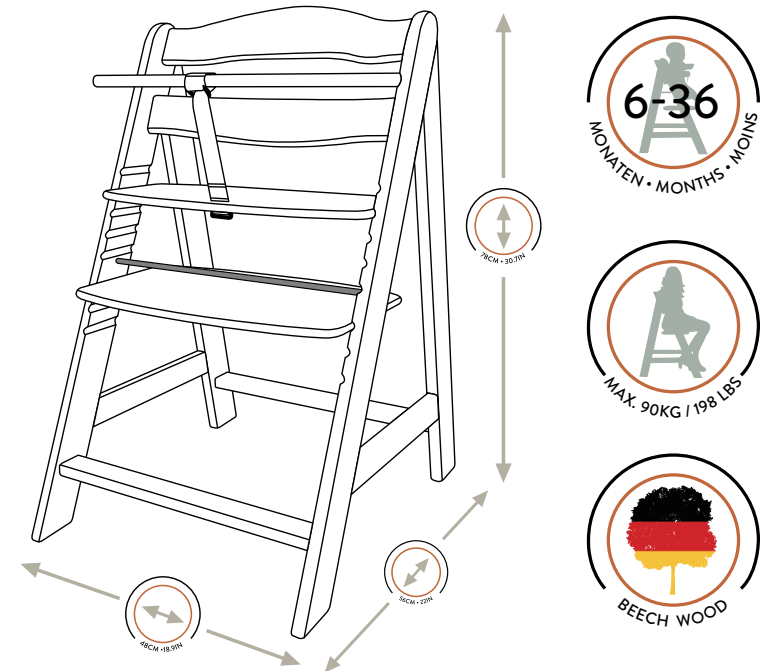

# SKY FEEDING SET 2 IN 1



N610010



*The Sky's the Limit!*

# EZ PLAY TENT



U680009



U680010



U680005



*Happy Camper!*

- Open or Fold by one hand within a second
- Twist & Open / Twist & Fold mechanism make it easy to set up and fold
- Compact folding size easy for storage, storage bag is included
- Good size tent for either indoor or outdoor play, 6 fix pins are provided for outdoor use.
- Include extra canopy cover with UV sun protection and waterproof
- For child from 3 year and up
- Open size : 140(L) x 140(W) x 105(H) cm
- Folded size: 19 (L) x 19 (W) x 80.5 (H)cm
- HQ container qty around 2300 pieces



ARTICLE: 509 CREW WAGON

the  
FIVE O NINE  
Crew  
LITTLE PLANET



ITEM no.  
U970005



ITEM no.  
U970009



- PULL ALONG WAGON, DURABLE STEEL FRAME WITH PLASTIC BASE, MAX LOADING 50KG.
- 10" WHEELS WITH BEARING, FRONT STEERING FUNCTION FOR EASY MOVEMENT.
- PARKING BRAKE FOR BOTH REAR WHEELS FOR SAFETY PARKING.
- SPACE SIZE: 87 X 47.5 X 33.5CM, HANDLE HEIGHT 112.5CM

FIVE O NINE CREW  
FIVE O NINE CREW